



life AGLOW

HINKLEY

From the first glimmers of light across the morning sky to the soothing dusk that envelops us at the close of another day, our lives are made richer by the radiance of light.

LIGHT CREATES DIFFERENT
PERSPECTIVES, REKINDLES EMOTIONS
AND PROVIDES PROTECTION.

Light makes us joyous, rejuvenated, relaxed and celebratory, embracing us in its luminous warmth.



HINKLEY
LIGHTING

design • illuminate • enjoy



Light inspires our outlook and our lives, brightening each moment spent with family and friends.

AT HINKLEY LIGHTING,
WE ARE COMMITTED
TO KEEPING YOUR
LIFE ILLUMINATED,
ENLIGHTENED, AGLOW.

Fixtures shown above. Meridian 3872 BN, page 45



“WE ARE A FOURTH GENERATION FAMILY BUSINESS. WE’RE PROUD OF OUR HERITAGE AND EXCITED ABOUT OUR FUTURE.”

RICK WIEDEMER
President, Hinkley Lighting
Cleveland, Ohio

Hinkley Lighting is driven by a passion to create lighting fixtures that help our customers achieve the very best vision of their home and lifestyle.

Hinkley Lighting began in 1922 as a small family lighting company and has developed into one of the most well-respected designers and manufacturers of high-quality lighting fixtures in the world. Our lighting has always been defined by superior materials, distinctive designs and unparalleled craftsmanship. Continuing our family heritage with a fourth generation of visionary leaders in the lighting industry, Hinkley Lighting continues to evolve while maintaining its tradition of unique designs and enduring quality.

We understand that your home is so much more than a physical place; it’s an emotional space and an extension of your personal style. We are committed to creating lighting fixtures that blend design and function, adding that quiet sophistication to your home’s decor while effortlessly updating each room.

Explore all of our brands and find the perfect style to fulfill your lighting needs. Each of our collections is available in a wide range of designs, from elegant and traditional to sleek and contemporary. We use only the highest quality materials and offer an extensive array of finishes to complement every style of interior and exterior design.



HINKLEY LIGHTING : Classic, timeless collections featuring a variety of designs ranging from traditional to contemporary.



FREDRICK RAMOND : Chic, fashionable lighting with a focus on modern elegance and luxurious details.



HINKLEY LANDSCAPE LIGHTING : Combining sophistication with durability, this collection complements our outdoor lighting families and provides the latest technology and outstanding workmanship.

Hinkley Lighting has always stood for quality, innovative design and above all, a commitment to keeping your *lifeAGLOW*.



Fixtures shown above: Harbor 2572 TT, page 297

Location Photography: Rob Brinson Photography
 Product Photography: Richard Kronenberg Photography

CHANDELIERS

<i>Design Center</i>	31
Ashbury	46
Bloom	52
Bolla	72
Brantley	90
Cambridge	148
Carlton	136
Casa	126
Cello	110
Chandon	50
Cirrus	68
Cooper	94
Cordillera	122
Dunhill	118
Easton	54
Gentry	164
Gold Hill	124
Hampton	62
Hathaway	70
Marcellina	134
Mayflower	104
Meridian	44
Middlebury	106
Midtown	42
Mondrian	96
Parker	88
Piedmont	40
Plantation	138
Plymouth	114
Portofino	112
Rockford	158
Sloan	120
Stowe	98
Sussex	56
Thistledown	100
Tides	48
Valley	84
Veranda	130
Virginian	160
Yorktown	108



FREDRICK RAMOND 168

BATH

<i>Design Center</i>	181
A la Mode	219
Abbie	216
Addison	233
Alice	214
Anna	235
Ashbury	203

Ashley	199	Elm	310
Avery	201	Forum	392
Avon	206	Freeport	370
Bloom	231	Hanna	308
Bolla	236	Harbor	296
Brooke	229	Innsbruck	342
Bryanna	195	Key West	306
Cari	194	Kube	278
Carina	234	Ledgewood	320
Casa	243	Lucerne	348
Daphne	222	Luna	274
Devon	208	Manor House	398
Element	228	Monticello	350
Flynn	244	Montreal	380
Francoise	247	Nantucket	366
Isabella	245	Oak Park	309
Josie	232	Oxford	344
Lanza	220	Parkside	338
Lola	200	Pearl	394
Meridian	190	Plantation	382
Miley	225	Raley	396
Nico	198	Reef	294
Ocho	202	Regal	404
Olivia	230	Revere	362
Orb	193	Rowe Park	378
Pia	192	San Clemente	354
Pinnacle	204	San Mateo	304
Plantation	249	Saturn	260
Plymouth	239	Senator	395
Portofino	240	Sierra	286
Shelly	210	Sorrento	388
Stowe	241	Stratford	330
Taylor	196	Tahoe	340
Thistledown	242	Thistledown	316
Zoe	212	Titan	282
		Trafalgar	332
		Trellis	346
		Wabash	334
		Wellington	374
		Westwinds	364
		Windsor	390

OUTDOOR

<i>Design Center</i>	251	Posts & Pier Mounts	406
Atlantis	266		
Augusta	352		
Aurora	318		
Bolla	300		
Brynmar	376		
Buckley	328		
Camelot	402		
Cape Cod	368		
Casa	314		
Cascade	284		
Castelle	324		
Cherry Creek	336		
Clifton Beach	358		
Clifton Park	360		
Cordillera	312		
Dwell	288		
Edgewater	400		
Ellis	264		

HINKLEY LANDSCAPE LIGHTING 408

Numeric Index 414

Throughout the 2011-2012 Hinkley Lighting catalog, we have utilized a variety of important icons and finish codes to assist you with your lighting selections. Below is a key describing each of these icons in detail as well as a list of our extensive product finishes with abbreviated codes for easy reference.

HINKLEY ICONS



FIXTURE EXCEEDS 50LBS.
Indicates fixtures weighing over 50lbs. Fixtures must be supported independently of the outlet box unless the outlet box is UL listed for the appropriate weight. Required hardware included.



COMBINATION MOUNT
Indicates fixtures that are supplied with the means to be chain hung or mounted flush to the ceiling.



DIFFUSER INCLUDED
Indicates fixtures that come equipped with a diffuser to minimize bulb exposure and soften the intensity of light emitted.



OVAL-SHAPED FIXTURE
Indicates chandeliers that are oval in shape.



ADA COMPLIANT
Indicates fixtures that adhere to the standards and guidelines listed by the Americans with Disabilities Act.



INVISI-MOUNT
Indicates bath fixtures where the mounting hardware is hidden on the back plate.



DAMP LOCATION
Indicates fixtures that can withstand indirect moisture in a protected or sheltered environment.



SELECT-A-LITE
Indicates fixtures that come with sockets that can accept either candelabra or medium-based bulbs.



ENERGY SAVING (ES)
Indicates fixtures that have the option to be engineered as Energy Saving (ES). Fixtures come equipped with GU24 sockets and include self-ballasted, CFL bulbs. Meets California's Title 24 requirements.



DARK SKY (DS)
Indicates fixtures that have the option to be engineered as Dark Sky (DS). Fixtures come equipped with a captive reflector that minimizes light glare upward into the night sky.

Please note Dark Sky conversion may alter fixture construction.



ENERGY SAVING DARK SKY (ESDS)
Indicates fixtures that have the option to be engineered as Energy Saving Dark Sky (ESDS). Fixture comes equipped with the combined technology of Energy Saving (ES) and Dark Sky (DS) configurations. Meets California's Title 24 requirements.



ENERGY STAR (EST)
Indicates fixtures that have the option to be engineered as Energy Star qualified (EST). Fixtures meet strict energy efficiency guidelines set by the EPA and the DOE. Fixtures combine a GU24 socket together with a self-ballasted CFL bulb and a photocell.



LED
Fixtures come equipped with a fully integrated LED panel and built-in driver.



Fixture shown above: Ashbury 5086 CM, page 47

HINKLEY FINISHES

AI Aged Iron	BN Brushed Nickel	GR Golden Bronze	OB Olde Bronze	RI Rustic Iron	SZ Sienna Bronze
AN Antique Nickel	BR Brushed Bronze	HE Hematite	OC Old Copper	RK River Rock	TB Textured Black
AP Antique Copper	BS Brass	KZ Buckeye Bronze	OL Olde Black	RY Royal Bronze	TT Titanium
AR Anchor Bronze	BZ Bronze	MB Museum Black	OP Olde Penny	SB Spanish Bronze	VB Venetian Bronze
AS Aged Brass	CB Copper Bronze	MC Metro Copper	OW Off-White	SC Southern Clay	VK Vintage Black
AT Antique Bronze	CH Chocolat	MN Midnight Bronze	OZ Oil Rubbed Bronze	SK Satin Black	VZ Victorian Bronze
AU Auburn	CM Chrome	MO Mocha	PB Polished Brass	SL Silver Leaf	WH White
BB Burnished Brass	CO Solid Copper	MR Museum Bronze	PL Polished Antique Nickel	SN Sienna	
BC Brushed Caramel	EZ English Bronze	MT Metro Bronze	PW Pewter	SR Sterling	
BG Black Granite	FB Forum Bronze	MZ Matte Bronze	PZ Pearl Bronze	SS Stainless Steel	
BH Blacksmith	FI Forged Iron	NB Natural Brass	RB Regency Bronze	SU Summerstone	
BK Black	FZ French Bronze	NC Natural Copper		SW Satin White	

HINKLEY WANTS TO
HELP YOU ACHIEVE THE
ULTIMATE VISION FOR YOUR
HOME AND THE PERFECT
LIGHTING HAS THE POWER
TO TIE IT ALL TOGETHER.

Using this guide, you get a quick, concise overview of our entire line of fixtures and can review the Chandeliers, Bath, Outdoor, Pendants, Flush Mounts and Sconces at a glance. The name, page number and finishes for each fixture are listed below for easy identification.



ASHBURY
Pages 46-47
Chrome



BLOOM
Pages 52-53
Polished Antique Nickel



BOLLA
Pages 80-83
Brushed Bronze



BOLLA
Pages 72-75
Brushed Nickel



BOLLA
Pages 76-79
Olde Bronze



BRANTLEY
Pages 90-91
Oil Rubbed Bronze



BRANTLEY
Pages 92-93
Textured Black



CAMBRIDGE
Pages 148-150
Burnished Brass



CAMBRIDGE
Pages 154-156
Olde Bronze



CAMBRIDGE
Pages 151-153
Pewter



CARLTON
Pages 136-137
Silver Leaf



CASA
Pages 126-129
Olde Black



CELLO
Pages 110-111
Antique Bronze



CHANDON
Pages 50-51
Sterling



CIRRUS
Pages 68-69
Brushed Nickel

CHANDELIERS



COOPER
Pages 94-95
Oil Rubbed Bronze



CORDILLERA
Pages 122-123
Rustic Iron



DUNHILL
Pages 118-119
Royal Bronze



EASTON
Pages 54-55
Polished Antique Nickel



GENTRY
Pages 166-167
Pewter



GENTRY
Pages 164-165
Polished Brass



GOLD HILL
Pages 124-125
Olde Black



HAMPTON
Pages 62-64
Antique Nickel



HAMPTON
Pages 65-67
Brushed Bronze



HATHAWAY
Pages 70-71
Antique Nickel



HATHAWAY
Pages 70-71
Olde Bronze



MARCELLINA
Pages 134-135
Golden Bronze



MAYFLOWER
Pages 104-105
Olde Bronze



MERIDIAN
Pages 44-45
Brushed Nickel



MIDDLEBURY
Pages 106-107
Forged Iron



MIDTOWN
Pages 42-43
Brushed Nickel



MONDRIAN
Pages 96-97
Buckeye Bronze



PARKER
Pages 88-89
Buckeye Bronze



PIEDMONT
Pages 40-41
Brushed Nickel



PLANTATION
Pages 138-141
Burnished Brass



PLANTATION
Pages 142-145
Pearl Bronze



PLANTATION
Pages 146-147
Polished Antique Nickel



PLYMOUTH
Pages 114-117
Olde Bronze



PORTOFINO
Pages 112-113
Victorian Bronze



ROCKFORD
Pages 158-159
Forum Bronze

CHANDELIERS



SLOAN
Pages 120-121
Regency Bronze



STOWE
Pages 98-99
Metro Copper



SUSSEX
Pages 56-58
Brushed Nickel



SUSSEX
Pages 59-61
English Bronze



THISTLEDOWN
Pages 100-102
Victorian Bronze



TIDES
Pages 48-49
Chrome



VALLEY
Pages 84-85
Brushed Nickel



VALLEY
Pages 86-87
Vintage Black



VERANDA
Pages 130-133
Summerstone



VIRGINIAN
Pages 160-161
Pewter



VIRGINIAN
Pages 162-163
Polished Brass



YORKTOWN
Pages 108-109
Brushed Bronze



Fixture shown: Bolla 4656 BN, page 73

SCONCES



5062 BN
A la Mode, Page 219
8" W, 8" H



5062 BR
A la Mode, Page 219
8" W, 8" H



5850 BN
Abbie, Page 217
6¾" W, 7¾" H



5850 BC
Abbie, Page 218
6¾" W, 7¾" H



5850 CM
Abbie, Page 216
6¾" W, 7¾" H



5860 PL
Addison, Page 233
6½" W, 7½" H



5830 AN
Alice, Page 214
5¼" W, 8¾" H



5830 BR
Alice, Page 215
5¼" W, 8¾" H



5780 CM
Anna, Page 235
6" W, 8¾" H



5700 CM
Ashbury, Pages 47, 203
6" W, 8" H



5190 CM
Ashley, Page 199
5" W, 8½" H



5210 BN
Avery, Page 201
6½" W, 6¼" H



5550 BN
Avon, Page 207
7¼" W, 7½" H



5550 CM
Avon, Page 206
7¼" W, 7½" H



5870 PL
Bloom, Pages 53, 231
6¾" W, 9" H



4650 BN
Bolla, Page 73, 236
7¾" W, 8½" H



4650 BR
Bolla, Page 81, 237
7¾" W, 8½" H



4650 OB
Bolla, Page 77, 238
7¾" W, 8½" H



4630 OZ
Brantley, Page 91
4¾" W, 12¼" H



4630 TB
Brantley, Page 93
4¾" W, 12¼" H



5000 AN
Brooke, Page 229
5¼" W, 11½" H



5080 CM
Bryanna, Page 195
5½" W, 7½" H



4410 BB
Cambridge, Page 149
4½" W, 11" H



4410 OB
Cambridge, Page 155
4½" W, 11" H



4410 PW
Cambridge, Page 152
4½" W, 11" H

SCONCES



4412 BB
Cambridge, Page 149
16" W, 11" H



4412 OB
Cambridge, Page 155
16" W, 11" H



4412 PW
Cambridge, Page 152
16" W, 11" H



4640 BB
Cambridge, Page 150
4½" W, 13" H



4642 BB
Cambridge, Page 150
14" W, 13½" H



5520 CM
Carl, Page 194
9" W, 5¼" H



5430 PL
Carina, Page 234
5" W, 9" H



4772 SL
Carlton, Page 137
13½" W, 19" H



4010 OL
Casa, Page 128, 243
5" W, 10¾" H



5450 AT
Cello, Page 111
8½" W, 8¼" H



4690 SR
Chandon, Page 51
5¾" W, 11½" H



4680 OZ
Cooper, Page 95
10" W, 8" H



4090 RI
Cordillera, Page 123
7½" W, 22" H



5070 BN
Devon, Page 209
5½" W, 8" H



5070 CM
Devon, Page 208
5½" W, 8" H



4590 RY
Dunhill, Page 119
6¼" W, 11¼" H



3980 PL
Easton, Page 55
5" W, 11" H



5220 BN
Element, Page 228
5¼" W, 7" H



5820 BH
Flynn, Page 244
7¾" W, 4½" H



5580 BB
Francoise, Page 247
6" W, 10¾" H



5580 PL
Francoise, Page 248
6" W, 10¾" H



5640 OL
Gold Hill, Page 125
5¼" W, 12½" H



3202 AN
Hampton, Page 63
15" W, 12" H



3202 BR
Hampton, Page 66
15" W, 12" H



3210 AN
Hampton, Page 63
6¾" W, 12" H

SCONCES



3210 BR
Hampton, Page 66
6¾" W, 12" H



5390 BB
Isabella, Page 246
5½" W, 10" H



5390 PL
Isabella, Page 245
5½" W, 10" H



5370 BN
Josie, Page 232
4½" W, 8½" H



5100 AN
Lanza, Page 220
7¼" W, 12" H



5100 BR
Lanza, Page 221
7¼" W, 12" H



5770 BN
Lola, Page 200
5½" W, 10" H



4400 GR
Marcellina, Page 135
6½" W, 19" H



5670 OB
Mayflower, Page 105
5" W, 10¾" H



3870 BN
Meridian, Page 45
5" W, 11¼" H



5590 BN
Meridian, Pages 45, 191
5" W, 8" H



5590 CM
Meridian, Page 190
5" W, 8" H



3760 FI
Middlebury, Page 107
9¼" W, 12¾" H



4970 BN
Midtown, Page 43
5" W, 8" H



5050 BC
Miley, Page 227
4½" W, 6½" H



5050 BN
Miley, Page 226
4½" W, 6½" H



5050 CM
Miley, Page 225
4½" W, 6½" H



5500 BN
Nico, Page 198
5½" W, 7½" H



5420 CM
Ocho, Page 202
6" W, 6" H



5750 AN
Olivia, Page 230
5¼" W, 8¼" H



5750 BR
Olivia, Page 230
5¼" W, 8¼" H



5130 CM
Orb, Page 193
6" W, 7" H



4430 KZ
Parker, Page 89
5¼" W, 12" H



5170 BN
Pia, Page 192
4½" W, 7" H



3740 BN
Piedmont, Page 41
4½" W, 9½" H

SCONCES



3742 BN
Piedmont, Page 41
11" W, 9" H



5250 AN
Pinnacle, Page 205
5" W, 9" H



5250 CM
Pinnacle, Page 204
5" W, 9" H



4140 BB
Plantation, Page 140
6" W, 14½" H



4140 PZ
Plantation, Page 144
6" W, 14½" H



4880 BB
Plantation, Page 139
6" W, 15" H



4880 PL
Plantation, Page 146
6" W, 15" H



4880 PZ
Plantation, Page 143
6" W, 15" H



5310 BB
Plantation, Pages 140, 249
5" W, 8¾" H



5310 PL
Plantation, Pages 147, 250
5" W, 8¾" H



5310 PZ
Plantation, Page 144
5" W, 8¾" H



4240 OB
Plymouth, Page 115
6½" W, 14" H



5470 OB
Plymouth, Page 115, 239
5½" W, 9½" H



5560 VZ
Portofino, Page 113, 240
5" W, 12" H



4620 FB
Rockford, Page 159
5" W, 13" H



4622 FB
Rockford, Page 159
14" W, 13½" H



5010 BN
Shelly, Page 211
5½" W, 9½" H



5010 CM
Shelly, Page 210
5½" W, 9½" H



4540 RB
Sloan, Page 121
4¾" W, 16" H



4720 MC
Stowe, Page 99, 241
5" W, 14" H



4790 BN
Sussex, Page 57
4½" W, 17¾" H



4790 EZ
Sussex, Page 60
4½" W, 17¾" H



4792 BN
Sussex, Page 57
15½" W, 15¾" H



4792 EZ
Sussex, Page 60
15½" W, 15¾" H



5020 BN
Taylor, Page 197
7¾" W, 6" H

SCONCES



5020 CM
Taylor, Page 196
7¾" W, 6" H



5680 VZ
Thistledown, Page 101, 242
5¾" W, 12¼" H



4780 CM
Tides, Page 49
4½" W, 12" H



4700 VK
Valley, Page 87
5¼" W, 21" H



4700 BN
Valley, Page 85
5¼" W, 21" H



4802 SU
Veranda, Page 131
14½" W, 17¾" H



5120 PB
Virginian, Page 163
4¼" W, 11" H



5120 PW
Virginian, Page 161
4¼" W, 11" H



5124 PB
Virginian, Page 163
13" W, 11" H



5124 PW
Virginian, Page 161
11" W, 11" H



3620 BR
Yorktown, Page 109
4¾" W, 13" H



3622 BR
Yorktown, Page 109
13¾" W, 15" H



5980 CM
Zoe, Page 212
5½" W, 7¾" H



1645 BZ, 1646 BZ
Atlantis, Page 267
9" W, 5¼" H



1645 SK, 1646 SK
Atlantis, Page 273
9" W, 5¼" H



1645 SW, 1646 SW
Atlantis, Page 271
9" W, 5¼" H



1645 TT, 1646 TT
Atlantis, Page 269
9" W, 5¼" H



1648 BZ
Atlantis, Page 266
6" W, 16" H



1648 SK
Atlantis, Page 273
6" W, 16" H



1648 TT
Atlantis, Page 268
6" W, 16" H



1648 SW
Atlantis, Page 270
6" W, 16" H



1649 BZ
Atlantis, Page 266
9" W, 24" H



1649 SK
Atlantis, Page 272
9" W, 24" H



1649 TT
Atlantis, Page 268
9" W, 24" H



1650 BZ
Atlantis, Page 266
6¼" W, 10½" H



1650 TT
Atlantis, Page 268
6¼" W, 10½" H



3610 BB
Cambridge, Page 149
14½" W, 18" H



3610 OB
Cambridge, Page 155
14½" W, 18" H



3610 PW
Cambridge, Page 152
14½" W, 18" H



4300 OL
Casa, Page 128
5" W, 24" H



1830 BZ
Cascade, Page 285
8" W, 14½" H



1830 SK
Cascade, Page 285
8" W, 14½" H



1830 TT
Cascade, Page 285
8" W, 14½" H



1834 BZ
Cascade, Page 284
8" W, 18" H



1834 SK
Cascade, Page 285
8" W, 18" H



1834 TT
Cascade, Page 285
8" W, 18" H



3800 BN
Cirrus, Page 69
15" W, 6½" H



5920 BN
Daphne, Page 223
8½" W, 9" H





5920 BR
Daphne, Page 224
8½" W, 9" H



5920 CM
Daphne, Page 222
8½" W, 9" H



1647 BZ
Luna, Page 276
9" W, 9" H



1647 SK
Luna, Page 276
9" W, 9" H



1647 SW
Luna, Page 276
9" W, 9" H



1647 TT
Luna, Page 276
9" W, 9" H



1660 BZ
Luna, Page 275
6" W, 16" H



1660 SK
Luna, Page 275
6" W, 16" H



1660 TT
Luna, Page 274
6" W, 16" H



1664 BZ
Luna, Page 275
9" W, 24" H



1664 SK
Luna, Page 275
9" W, 24" H



1664 TT
Luna, Page 274
9" W, 24" H



1666 BZ, 1667 BZ
Luna, Page 277
9" W, 5¼" H



1666 SK, 1667 SK
Luna, Page 277
9" W, 5¼" H



1666 TT, 1667 TT
Luna, Page 277
9" W, 5¼" H



4570 KZ
Mondrian, Page 97
7" W, 11" H



4572 KZ
Mondrian, Page 97
7" W, 24" H



5170 BN
Pia, Page 192
4½" W, 7" H



1908 MT
Saturn, Page 263
7¼" W, 12½" H



1908 SS
Saturn, Page 261
7¼" W, 12½" H



4900 BN
Sussex, Page 57
14" W, 14" H



4900 EZ
Sussex, Page 60
14" W, 14" H



4800 SU
Veranda, Page 132
13" W, 12¼" H



INDOOR FLUSH MOUNTS



5781 CM
Anna, Page 235
17" Dia., 6½" H



5191 CM
Ashley, Page 199
15¾" Dia., 7" H



5551 BN
Avon, Page 207
15" Dia., 7¾" H



5551 BR
Page 215
15" Dia., 7¾" H



5551 CM
Avon, Page 206
15" Dia., 7¾" H



5551 OZ
15" Dia., 7¾" H



4371 PL
Bloom, Pages 53, 231
15" Dia., 8½" H



4660 BN
Bolla, Pages 75, 236
16¾" Dia., 8" H



4660 BR
Bolla, Pages 83, 237
16¾" Dia., 8" H



4660 OB
Bolla, Pages 79, 238
16¾" Dia., 8" H



4631 OZ
Brantley, Page 91
17" Dia., 7" H



4631 TB
Brantley, Page 93
17" Dia., 7" H



3612 BB
Cambridge, Page 150
14½" Dia., 13" H



3612 OB
Cambridge, Page 156
14½" Dia., 13" H



3612 PW
Cambridge, Page 153
14½" Dia., 13" H



3616 BB
Cambridge, Page 150
16¼" Dia., 7½" H



3616 OB
Cambridge, Page 156
16¼" Dia., 7½" H



3616 PW
Cambridge, Page 153
16¼" Dia., 7½" H



3501 OL
Casa, Pages 127, 243
14¼" Dia., 8¾" H



3472 PB
Gentry, Page 165
9½" Dia., 9¼" H



3472 PW
Gentry, Page 167
9½" Dia., 9¼" H



3473 PB
Gentry, Page 165
11½" Dia., 9½" H



3473 PW
Gentry, Page 167
11½" Dia., 9½" H



5421 BN
Pages 201, 209, 211, 217,
219, 220, 226, 230
17" Dia., 7" H



5421 BR
Pages 218, 219, 221,
227, 230
17" Dia., 7" H

INDOOR FLUSH MOUNTS



5421 CM
Ocho, Pages 194, 195, 202, 203,
208, 210, 212, 216, 225
17" Dia., 7" H



5421 OZ
17" Dia., 7" H



5251 AN
Pinnacle, Page 205
16¼" Dia., 7¼" H



5251 BR
16¼" Dia., 7¼" H



5251 CM
Pinnacle, Page 204
16¼" Dia., 7¼" H



5251 OZ
16¼" Dia., 7¼" H



4102 BB
Plantation, Pages 141, 249
12" Dia., 8" H



4102 CB
Plantation, Page 383
12" Dia., 8" H



4102 PL
Plantation, Pages 147, 250
12" Dia., 8" H



4102 PZ
Plantation, Page 145
12" Dia., 8" H



4881 BB
Plantation, Pages 141, 249
16" Dia., 8¾" H



4881 CB
Plantation, Page 383
16" Dia., 8¾" H



4881 PL
Plantation, Pages 147, 250
16" Dia., 8¾" H



4881 PZ
Plantation, Page 145
16" Dia., 8¾" H



4241 OB
Plymouth, Pages 116, 239
17½" Dia., 8¾" H



3712 FB
Rockford, Page 159
14½" Dia., 12¼" H



3716 FB
Rockford, Page 159
16¼" Dia., 7½" H



4721 MC
Stowe, Pages 99, 241
15½" Dia., 6¾" H



4171 VZ
Thistledown, Pages 101, 242
15¼" Dia., 8" H



3723 SU
Veranda, Page 133
17" Dia., 13¼" H



4891 SU
Veranda, Page 131
16" Dia., 8" H

OVERSCALED SEMI-FLUSH MOUNTS

Gaining popularity as a chic alternative to chandeliers is the over-scaled flush mount ceiling fixture. This fixture can make a strong design statement, whether modern and minimalist or with all the glamour of a crystal-embellished design. Replacing your overhead lighting with a grand fixture of this scale can create a dramatic focal point in bedrooms, home offices, laundry rooms or any space where a traditionally-sized flush mount appears inadequate.



4669 BR
Bolla, Page 83
23¼" Dia., 16" H



4669 BN
Bolla, Page 75
23¼" Dia., 16" H



4669 OB
Bolla, Page 79
23¼" Dia., 16" H



4311 OL
Casa, Page 129
23" Dia., 14" H



3804 BN
Cirrus, Page 69
20" Dia., 12" H



3805 BN
Cirrus, Page 69
28" Dia., 12" H



3201 AN
Hampton, Page 64
20" Dia., 12" H



3201 BR
Hampton, Page 67
20" Dia., 12" H



3211 AN
Hampton, Page 63
26" Dia., 14½" H



3211 BR
Hampton, Page 66
26" Dia., 14½" H



3221 AN
Hathaway, Page 71
20¾" Dia., 12¼" H



3221 OB
Hathaway, Page 71
20¾" Dia., 12¼" H



4702 BN
Valley, Page 85
23" Dia., 13¾" H



4702 VK
Valley, Page 87
23" Dia., 13¾" H



4801 SU
Veranda, Page 132
20" Dia., 16" H

MINI-PENDANTS

All pendants come standard with 1-6" and 2-12" stems. Additional stems are available to achieve desired height. Pendants include a pivoting socket for hanging on slanted ceilings. Pendants shown here with 2-12" stems.



4087 CM
Ashbury
Page 47
5½" Dia.
42½" H Max.



4377 PL
Bloom
Page 53
6¾" Dia.
41¾" H Max.



4667 BN
Bolla
Page 74
7¾" Dia.
39½" H Max.



4667 BR
Bolla
Page 82
7¾" Dia.
39½" H Max.



4667 OB
Bolla
Page 78
7¾" Dia.
39½" H Max.



4637 OZ
Brantley
Page 91
4¾" Dia.
41¼" H Max.



4637 TB
Brantley
Page 93
4¾" Dia.
41¼" H Max.



4017 OL
Casa
Page 129
5½" Dia.
45" H Max.



4567 AT
Cello
Page 111
8½" Dia.
40¾" H Max.



3987 PL
Easton
Page 55
5" Dia.
39¾" H Max.



4057 OL
Gold Hill
Page 125
5¼" Dia.
47" H Max.



3207 AN
Hampton
Page 64
7" Dia.
44" H Max.



3207 BR
Hampton
Page 67
7" Dia.
44" H Max.



4167 OB
Mayflower
Page 105
5" Dia.
41¾" H Max.

MINI-PENDANTS



3877 BN
Meridian
Page 45
7½" Dia.
36¾" H Max.



4437 KZ
Parker
Page 89
4¾" Dia.
46½" H Max.



5317 BB
Plantation
Page 141
5" Dia.
40¾" H Max.



5317 PL
Plantation
Page 146
5" Dia.
40¾" H Max.



5317 PZ
Plantation
Page 145
5" Dia.
40¾" H Max.



4247 OB
Plymouth
Page 115
6½" Dia.
43" H Max.



4117 VZ
Portofino
Page 113
5" Dia.
39¾" H Max.



4547 RB
Sloan
Page 121
6" Dia.
50" H Max.



4727 MC
Stowe
Page 99
5" Dia.
43¾" H Max.



4717 RB
Tahoe
7" Dia.
39¾" H Max.



4177 VZ
Thistledown
Page 101
5¼" Dia.
43½" H Max.



4707 BN
Valley
Page 85
5¼" Dia.
45¼" H Max.



4707 VK
Valley
Page 87
5¼" Dia.
45¼" H Max.



4897 SU
Veranda
Page 133
8¾" Dia.
45" H Max.

MID-PENDANTS

All pendants come standard with 1-6" and 2-12" stems. Additional stems are available to achieve desired height. Pendants include a pivoting socket for hanging on slanted ceilings. Pendants shown here with 2-12" stems.



4661 BN
Bolla, Page 74
15½" Dia., 48" H Max.



4661 BR
Bolla, Page 82
15½" Dia., 48" H Max.



4661 OB
Bolla, Page 78
15½" Dia., 48" H Max.



4151 OB
Mayflower, Page 105
14" Dia., 42½" H Max.



4577 KZ
Mondrian, Page 97
7" Dia., 43½" H Max.



1322 BK
Dwell, Page 289
6¼" Dia., 54" H Max.



1322 HE
Dwell, Page 293
6¼" Dia., 54" H Max.



1322 KZ
Dwell, Page 291
6¼" Dia., 54" H Max.



1328 BK
Dwell, Page 289
8¼" Dia., 57" H Max.



4097 RI
Cordillera, Page 123
7½" Dia., 55½" H Max.



3100 BN



3100 OB



3101 BN



3101 OB



3102 BN



3102 OB



3109 BN
(Bracket)



3109 OB
(Bracket)

PENDANTS, STEMS AND BRACKETS

ITEM	WIDTH	HEIGHT	BACK PLATE/CANOPY	WIRE/CHAIN	STEMS INCLUDED	BULBS	AVAILABLE FINISHES
3100 BN	10" Dia.	10", 42¼" Max.*	5¼" Dia. Canopy	10' Wire	1-6", 2-12"	1-100w Med.	BN, OB
3100 OB	10" Dia.	10", 42¼" Max.*	5¼" Dia. Canopy	10' Wire	1-6", 2-12"	1-100w Med.	BN, OB
3101 BN	8" Dia.	12¼", 44¾" Max.*	5¼" Dia. Canopy	10' Wire	1-6", 2-12"	1-100w Med.	BN, OB
3101 OB	8" Dia.	12¼", 44¾" Max.*	5¼" Dia. Canopy	10' Wire	1-6", 2-12"	1-100w Med.	BN, OB
3102 BN	8½" Dia.	9¾", 42¼" Max.*	5¼" Dia. Canopy	10' Wire	1-6", 2-12"	1-100w Med.	BN, OB
3102 OB	8½" Dia.	9¾", 42¼" Max.*	5¼" Dia. Canopy	10' Wire	1-6", 2-12"	1-100w Med.	BN, OB
3109 BN**	27½" W	3½"	4½" W, 7" L Canopy				BN, OB
3109 OB**	27½" W	3½"	4½" W, 7" L Canopy				BN, OB
4506	½" Dia.	6" (stem)					ALL
4512	½" Dia.	12" (stem)					ALL

*All pendants come standard with 1-6" and 2-12" stems. Additional stems are available in every pendant finish to achieve desired height. Please designate appropriate finish when ordering. **Brackets can be used in conjunction with pendants to consolidate fixture wiring of two pendants into one outlet box.



A LA MODE
Page 219
Brushed Bronze



A LA MODE
Page 219
Brushed Nickel



ABBIE
Page 217
Brushed Nickel



ABBIE
Page 218
Brushed Caramel



ABBIE
Page 216
Chrome



ADDISON
Page 233
Polished Antique Nickel



ALICE
Page 214
Antique Nickel



ALICE
Page 215
Brushed Bronze



ANNA
Page 235
Chrome



ASHBURY
Page 203
Chrome



ASHLEY
Page 199
Chrome



AVERY
Page 201
Brushed Nickel



AVON
Page 207
Brushed Nickel



AVON
Page 206
Chrome



BLOOM
Page 231
Polished Antique Nickel



BOLLA
Page 237
Brushed Bronze



BOLLA
Page 236
Brushed Nickel



BOLLA
Pages 238
Olde Bronze



BROOKE
Page 229
Antique Nickel



BRYANNA
Page 195
Chrome



CARI
Page 194
Chrome



CARINA
Page 234
Polished Antique Nickel



CASA
Page 243
Olde Black



DAPHNE
Page 224
Brushed Bronze



DAPHNE
Page 223
Brushed Nickel



DAPHNE
Page 222
Chrome



DEVON
Page 209
Brushed Nickel



DEVON
Page 208
Chrome



ELEMENT
Page 228
Brushed Nickel



FLYNN
Page 244
Blacksmith



FRANCOISE
Page 247
Burnished Brass



FRANCOISE
Page 248
Polished Antique Nickel



ISABELLA
Page 246
Burnished Brass



ISABELLA
Page 245
Polished Antique Nickel



JOSIE
Page 232
Brushed Nickel



LANZA
Page 220
Antique Nickel



LANZA
Page 221
Brushed Bronze



LOLA
Page 200
Brushed Nickel



MERIDIAN
Page 191
Brushed Nickel



MERIDIAN
Page 190
Chrome



MILEY
Page 226
Brushed Nickel



MILEY
Page 227
Brushed Caramel



MILEY
Page 225
Chrome



NICO
Page 198
Brushed Nickel



OCHO
Page 202
Chrome



OLIVIA
Page 230
Antique Nickel



OLIVIA
Page 230
Brushed Bronze



ORB
Page 193
Chrome



PIA
Page 192
Brushed Nickel



PINNACLE
Page 205
Antique Nickel

BATH



PINNACLE
Page 204
Chrome



PLANTATION
Page 249
Burnished Brass



PLANTATION
Page 250
Polished Antique Nickel



PLYMOUTH
Page 239
Olde Bronze



PORTOFINO
Page 240
Victorian Bronze



SHELLY
Page 211
Brushed Nickel



SHELLY
Page 210
Chrome



STOWE
Pages 241
Metro Copper



TAYLOR
Page 197
Brushed Nickel



TAYLOR
Page 196
Chrome



THISTLEDOWN
Page 242
Victorian Bronze



ZOE
Page 212
Chrome



Fixture shown: Lanza 5100 AN, page 220



ATLANTIS
Pages 266-267
Bronze



ATLANTIS
Pages 272-273
Satin Black



ATLANTIS
Pages 270-271
Satin White



ATLANTIS
Pages 268-269
Titanium



AUGUSTA
Pages 352-353
Copper Bronze



AURORA
Pages 318-319
Metro Bronze



BOLLA
Pages 302-303
Black



BOLLA
Pages 300-301
Olde Bronze



BRYNMAR
Pages 376-377
Regency Bronze



BUCKLEY
Page 329
Black



BUCKLEY
Page 328
Olde Bronze



CAMELOT
Pages 402-403
Black



CAPE COD
Pages 368-369
Sienna Bronze



CASA
Pages 314-315
Olde Black



CASCADE
Pages 284-285
Bronze



CASCADE
Pages 284-285
Satin Black



CASCADE
Pages 284-285
Titanium



CASTELLE
Pages 326-327
Black



CASTELLE
Pages 324-325
Bronze



CHERRY CREEK
Pages 336-337
Vintage Black



CLIFTON BEACH
Pages 358-359
Antique Copper



CLIFTON PARK
Pages 360-361
Copper Bronze



CORDILLERA
Pages 312-313
Buckeye Bronze



DWELL
Pages 288-289
Black



DWELL
Pages 290-291
Buckeye Bronze



DWELL
Pages 292-293
Hematite



EDGEWATER
Pages 400-401
Black



ELLIS
Pages 264-265
Black



ELLIS
Pages 264-265
Buckeye Bronze



ELLIS
Pages 264-265
Stainless Steel



OUTDOOR



ELM
Pages 310-311
Regency Bronze



FORUM
Pages 392-393
French Bronze



FREEPORT
Pages 372-373
Oil Rubbed Bronze



FREEPORT
Pages 370-371
Old Penny



HANNA
Page 308
Metro Bronze



HARBOR
Pages 298-299
Anchor Bronze



HARBOR
Pages 296-297
Titanium



INNSBRUCK
Pages 342-343
Regency Bronze



KEY WEST
Pages 306-307
Regency Bronze



KUBE
Pages 278-281
Bronze



KUBE
Pages 278-281
Satin Black



KUBE
Pages 278-281
Satin White



KUBE
Pages 278-281
Titanium



LEDGEWOOD
Pages 320-321
Museum Bronze



LEDGEWOOD
Pages 322-323
Vintage Black



LUCERNE
Pages 348-349
Copper Bronze



LUNA
Pages 274-277
Bronze



LUNA
Pages 274-277
Satin Black



LUNA
Pages 274-277
Titanium



MANOR HOUSE
Pages 398-399
Black



MONTICELLO
Pages 350-351
Copper Bronze



MONTREAL
Pages 380-381
Aged Iron



NANTUCKET
Pages 366-367
Aged Brass



OAK PARK
Page 309
Copper Bronze



OXFORD
Pages 344-345
Midnight Bronze



PARKSIDE
Pages 338-339
Oil Rubbed Bronze



PEARL
Page 394
Black



PLANTATION
Pages 382-384
Copper Bronze



PLANTATION
Pages 386-387
Pearl Bronze



RALEY
Pages 396-397
Museum Black



REEF
Page 294
Hematite



REEF
Page 295
Victorian Bronze



REGAL
Pages 404-405
Black Granite



REVERE
Pages 362-363
Sienna



ROWE PARK
Pages 378-379
Pearl Bronze



SAN CLEMENTE
Pages 354-355
Copper Bronze



SAN CLEMENTE
Pages 356-357
Museum Black



SAN MATEO
Pages 304-305
Regency Bronze



SATURN
Pages 262-263
Metro Bronze



SATURN
Pages 260-261
Stainless Steel



SENATOR
Page 395
Black



SIERRA
Page 286-287
Spanish Bronze



SORRENTO
Pages 388-389
Aged Iron



STRATFORD
Page 330
Auburn



STRATFORD
Page 331
Museum Black



TAHOE
Pages 340-341
Regency Bronze



THISTLEDOWN
Pages 316-317
Victorian Bronze



TITAN
Pages 282-283
Buckeye Bronze



TITAN
Pages 282-283
Hematite



TITAN
Pages 282-283
Titanium



TRAFALGAR
Page 332
Mocha



TRAFALGAR
Page 333
Museum Black



TRELIS
Pages 346-347
Regency Bronze



WABASH
Page 334
Mocha



WABASH
Page 335
Museum Black



WELLINGTON
Pages 374-375
Regency Bronze



WESTWINDS
Pages 364-365
Sienna



WINDSOR
Pages 390-391
River Rock

OUTDOOR FLUSH MOUNTS



2633 BK
Bolla, Page 303
16¾" Dia., 8" H



2633 OB
Bolla, Page 301
16¾" Dia., 8" H



1712 BK
Camelot, Page 403
11¾" Dia., 9¾" H



2203 SZ
Cape Cod, Page 369
7" Dia., 9¾" H



1273 VK
Cherry Creek, Page 337
12" W, 7¼" H



2429 CB
Clifton Park, Page 361
12½" Dia., 6¾" H



1683 BK
Edgewater, Page 401
13" Dia., 9" H



2573 AR
Harbor, Page 299
12¼" W, 7" H



2573 TT
Harbor, Page 297
12¼" W, 7" H



1613 RB
Key West, Page 307
15" Dia., 8¾" H



1763 BZ
Kube, Page 280
6" W, 6¼" H



1763 SK
Kube, Page 280
6" W, 6¼" H



1763 SW
Kube, Page 280
6" W, 6¼" H



1763 TT
Kube, Page 280
6" W, 6¼" H



1663 BZ
Luna, Page 277
8" W, 7¼" H



1663 SK
Luna, Page 277
8" W, 7¼" H



1663 TT
Luna, Page 277
8" W, 7¼" H



2313 CB
Lucerne, Page 349
12½" Dia., 7¼" H



1243 MN
Oxford, Page 345
16¼" Dia., 7½" H



2123 PZ
Plantation, Page 387
16" Dia., 8¾" H



2128 PZ
Plantation, Page 387
12" Dia., 8" H



4102 BB
Plantation, Pages 141, 249
12" Dia., 8" H



4102 CB
Plantation, Page 383
12" Dia., 8" H



4102 PL
Plantation, Pages 147, 250
12" Dia., 8" H



4102 PZ
Plantation, Page 145
12" Dia., 8" H

OUTDOOR FLUSH MOUNTS



4881 BB
Plantation, Pages 141, 249
16" Dia., 8¾" H



4881 CB
Plantation, Page 383
16" Dia., 8¾" H



4881 PL
Plantation, Pages 147, 250
16" Dia., 8¾" H



4881 PZ
Plantation, Page 145
16" Dia., 8¾" H



1713 BG
Regal, Page 405
11¾" Dia., 9" H



2443 CB
Augusta, Page 353
Monticello, Page 351
San Clemente, Page 355
15¾" Dia., 9" H



2443 MB
San Clemente, Page 357
15¾" Dia., 9" H



1253 RB
San Mateo, Page 305
16" Dia., 9½" H



2243 RB
Tahoe, Page 341
9½" Dia., 6" H



4171 VZ
Thistledown, Pages 101, 242, 317
15¼" Dia., 8" H



2999 SN
Westwinds, Page 365
13½" Dia., 7½" H



1893 RK
Windsor, Page 391
12¾" Dia., 7" H



Fixtures shown: Thistledown 1281 VZ, page 317

STYLE TIPS & IDEAS from fabulous designers

While a home's interior is a thoughtful combination of personal style, architecture and decorative elements, lighting has the power to tie it all together. It is commonly considered the design element that makes the room. Lighting can create dynamic visual statements, enhance mood and atmosphere, and even alter the room's color. Whether building a new home, upgrading both interior and exterior lighting will make a powerful, and immediate impact.

As part of our Life Aglow campaign, Hinkley has collaborated with renowned interior designers to bring you design and lighting tips from the pros. Through individual interviews, Hinkley offers an inside perspective on how designers use lighting to enhance each space they create. Featuring designers from *House Beautiful's* "Next Wave of Designers to Watch" list, as well as other acclaimed designers and editors, we present this concise lighting design overview in three unique sections of our catalog: Chandelier, Bath and Outdoor Lighting.



AMY ELBERT
Senior Architecture Editor
Traditional Home Magazine

Amy Elbert is Senior Architecture Editor at *Traditional Home* magazine, where she writes and edits articles on the subjects of new home construction, whole-house renovations, additions, and kitchen and bath projects. She also oversees *Traditional Home's* coverage of home-related technology and is responsible for a standing Green Space section, which features eco-friendly design and building products and projects.



JILL SHARP BRINSON
Jill Sharp Style, Atlanta, Georgia

Jill Brinson of Jill Sharp Style specializes in creating inspiring ideas in the world of commercial and editorial styling and creative direction. Jill has a formal background in interior architecture and design and thrives on her passion for product design and clever collaborations with individuals and companies. Jill has been featured on the pages of *House Beautiful*, *Southern Accents*, *Self Magazine* and *The Los Angeles Times* and her designs continue to be discussed online throughout coveted design blogs. jillsharpstyle.com



CARRIE FUNDINGSLAND
Houseplay Interiors
Los Angeles, California

Named in *House Beautiful's* "Next Wave of Interior Designers to Watch," Carrie believes your home is a sanctuary and should be a place of peace and inspiration. Carrie has worked on multiple projects all over the world and her impressive client list includes celebrities such as Melanie Griffith and James Denton. houseplayinc.com



LISA RACHELLE MCDENNON
Lisa Rachelle McDennon
Laguna Beach, California

Lisa owns and runs LRM Interior Design. This ASID (American Society of Interior Designers) award winning studio is up for two more ASID awards this year. Named in *House Beautiful's* "Next Wave of Interior Designers to Watch" LRM Interior Design specializes in full service residential and commercial design and has received coverage in *House Beautiful*, *Romantic Homes* and *Victorian Homes* magazines. Her style is described as "Delicious, Dreamy, Decadent." lrmdesign.com



KYLE SCHUNEMAN
Live Well Designs
Los Angeles, California

This rising style expert has a client list including Target, Howard Miller Furniture, *Vogue Living* and *Traditional Home* magazines. Recently named in *House Beautiful's* "Next Wave of Interior Designers to Watch," his inventive work has been nationally showcased on HGTV and the Style Network and he continues to appear in national shelter publications such as *Real Simple*, *Garden Design* and *Dwell*. livewelldesigns.com



REBECCA TIER SOSKIN
Rebecca Tier Soskin Design
New York, New York

Named in *House Beautiful's* "Next Wave of Interior Designers to Watch," Rebecca's philosophy is that each space she designs should become a collaboration of her client's personality and her own innovative and elegant approach to design. She enjoys integrating simple styles with a hint of vintage and a splash of boldness. Her elite clientele continues to grow. rebeccasoskin.com



SARA GILBANE SULLIVAN
Sara Gilbane Interiors
New York, New York

Sara is best known for her classic, modern-traditional style, combining low-key and elegant pieces with a youthful, chic flair grounded in practicality. Named in *House Beautiful's* "Next Wave of Interior Designers to Watch," her work has graced the pages of *Traditional Home*, *House Beautiful* and *House and Home* magazines and continually appears online in design sources such as *Lonny* magazine and several coveted design blogs. saragilbaneinteriors.com

CHANDELIERS

DEFINE YOUR DECOR



“Chandeliers evoke feelings of grandeur, romanticism, whimsy, sophistication...”

- CARRIE FUNDINGSLAND

Ashbury	46-47	Cooper	94-95	Meridian	44-45	Sloan	120-121
Bloom	52-53	Cordillera	122-123	Middlebury	106-107	Stowe	98-99
Bolla	72-83	Dunhill	118-119	Midtown	42-43	Sussex	56-61
Brantley	90-93	Easton	54-55	Mondrian	96-97	Thistledown	100-102
Cambridge	148-156	Gentry	164-167	Parker	88-89	Tides	48-49
Carlton	136-137	Gold Hill	124-125	Piedmont	40-41	Valley	84-87
Casa	126-129	Hampton	62-67	Plantation	138-147	Veranda	130-133
Cello	110-111	Hathaway	70-71	Plymouth	114-117	Virginian	160-163
Chandon	50-51	Marcellina	134-135	Portofino	112-113	Yorktown	108-109
Cirrus	68-69	Mayflower	104-105	Rockford	158-159		

CHANDELIER *chic*

THE CHANDELIER HAS EVOLVED INTO ONE OF THE MOST COMMANDING DISPLAYS OF PERSONALITY IN A ROOM. THEY CAN BE PLACED IN LIVING ROOMS, GREAT ROOMS, BATHROOMS, MASTER CLOSETS, CHILDREN'S ROOMS, KITCHENS...THE POSSIBILITIES ARE ENDLESS! THINK OF IT AS THE ULTIMATE ACCESSORY: A STATEMENT PIECE OF JEWELRY IN A SPACE, ADDING THAT EXTRA LAYER OF EXCITEMENT AND SOPHISTICATION. THE ILLUMINATION CAN CREATE A DRAMATIC STAGE FOR ENTERTAINING OR ADD A WHIMSICAL TOUCH TO A FORMAL SETTING, MAKING IT THE PERFECT FOCAL POINT FOR DESIGN INSPIRATION.

"The possibilities are endless! It really depends upon the chandelier. If it has crystals it will create a luxurious sparkle that can dress up the most boring of rooms. If it has a fabric shade or diffuser, it can create a soft warm overall glow. You can also create different moods with the same fixture, depending upon how brightly or dimly lit it is, or how high or low you hang it. You can also create different effects with using multiples or clusters of fixtures."

- Lisa Rachelle McDennon





perfect PLACEMENT

Sometimes rules are made to be broken! Not only are designers and homeowners experimenting with placing chandeliers in less traditional spaces in their homes, they are also getting creative about the placement within that room. Making the decision to hang a fixture lower or higher than recommended can add a creative twist to the presentation of your decor.

"I think the world is feeling less static about where chandeliers and pendants can and should be placed. I am using them lowered way down over coffee tables and end tables. When used in the application of end table, it replaces the pre-requisite lamp, which feels really fresh now. I think they can also be used to great effect on art walls – dangling in a lowered manner in front of or to the side of a group of framed items, large canvases, leaning canvases – whatever – they are essentially adding another layer of "art" to the mix."

– Jill Sharp Brinson

Fixture shown on page 31: Valley 4705 BN, page 85

Fixtures shown on page 32: Sussex 4798 BN, page 57;
Dwell 1328 BK, page 289

Fixture shown above: Chandon 4696 SR, page 51

A man in a dark suit and tie is sitting in a purple wingback armchair. In front of him is a round, rustic wooden table with several wooden bowls and a pear. A large, ornate chandelier with multiple frosted glass shades hangs from the ceiling. The room has green walls and a white door in the background. A staircase with blue carpeting and white railings is visible through the doorway.

“Chandelier placement depends on the height and size of the room and is really a personal preference. The current trend is to hang it in the middle of the room, the table, the central seating area, etc. Make it BIG and BOLD (as long as the room or table can handle it).”

—Rebecca Tier Soskin

mix & MATCH

Today's styles are uniquely eclectic and you should feel comfortable mixing and matching. Chandeliers lend themselves perfectly to this process. You can look for a chandelier that is inspired by the period reflected in the room you are putting it, but you don't have to. Many contemporary designs are a blend of traditional elements with modern materials which makes them work with a variety of decors. Still, when you are mixing styles it helps to stay consistent with your finish selections, which will support a cohesive look without standing in the way of your creativity.



BRIGHT *ideas*

Hinkley's catalog conveniently lists the maximum bulb wattage for each fixture. With this in mind, there are multiple bulb styles to choose from that will customize the look of your fixture, particularly when the bulbs are exposed.

From small flame tip candelabra-based bulbs to Edison-style medium base bulbs, making the right selection allows you to add your own personal style statement to each fixture. Additionally, installing a dimmer control is extremely important and will aid you in controlling the level of light, making a dramatic impact while defining the mood. Having this control also increases the functional flexibility of your space, allowing you to use the space for multiple activities like homework at the dining room table or a romantic dinner for two.

"I have played around in the last couple of years with using unexpected bulbs – round, modern vanity bulbs with a small lamp base really make a huge impact on the vibe of a chandelier and subsequently impact the light level that they throw."

– Jill Sharp Brinson

Fixtures shown on page 34: Cello 4568 AT, page 111
 Fixtures shown above: Casa 4018 OL, page 127;
 Virginian 5120 PW, page 161

SCONCE *savvy*

Often overlooked as a design element, sconces can act as a complement to a chandelier and encourage a layered effect, making the lighting and overall design of the room both appealing and functional. With the ability to direct light into the room at face level, wall sconces are perfect for balancing the amount of light in your space. It is a common misconception that sconces need to “match” the central lighting fixture in the room. They can equally complement such statement pieces by simply staying within the same finish family but choosing a varying style.

“Sconces naturally go with chandeliers and I don’t think they need to be the exact same style as the chandelier... Keep the metals and the finishes the same if you’re choosing different styles to create a harmonious flow.”

– Kyle Schuneman



Fixtures shown above : Hampton 3206 AN, page 62;
Virginian 5120 PW, page 161
Fixture shown on page 37: Ashbury 4087 CM, page 47



GROUP THERAPY

Another eye-catching design trend is to group small chandeliers or pendants together over a kitchen island, dining room table or coffee table. These smaller hanging fixtures can add a unique look and have just as much impact as one larger chandelier.

"It's fine to hang a pair of chandeliers in a large room if the room can handle it. If it's a smaller room, make sure the chandeliers aren't too oversized. Beyond that, a pair of pendants over your kitchen island or a grouping of smaller hanging fixtures in the right room can add a nice detail."

- Rebecca Tier Soskin -

"I just finished a room setting where I used 7 pendants hung over a huge table in varying heights - these were glass pendants with a decidedly Moroccan bent and it was great. Obviously committing to this statement when the room is getting wired is a must!"

- Jill Sharp Brinson -

"If they are quite small, a cluster of delicate whimsical chandeliers can work in a child's playroom or entry hall. Nothing too big and bulky... I am also a fan of hanging several decorative pendants at different heights to play with lighting for a more modern setting."

- Sarah Gilbane Sullivan -



a quick guide to
SIZING AND HANGING
YOUR CHANDELIER

Chandeliers are designed to float in a room as an important part of the decor. Too large and this fixture will overpower the space. Too small and it will look out of place. Placing a chandelier that is too small in a space is likely the biggest mistake. Great designers, therefore, tend to make their decisions on fixtures that may appear slightly larger than might be appropriate. It's generally always best to make the mistake on a fixture being too big than too small.



30"-32"
(recommended)

"I am a classicist at heart and observe the rules of proportion so with chandeliers placed over dining tables, I like the height to be about 30"-36" above the tables for optimal lighting."

— Sara Gilbane Sullivan



MEASUREMENT *guidelines*

To size a chandelier for your dining room, or to be the focal point of your space, measure the length and width of the room and add those figures together. The sum, converted to inches, will equal the diameter that you can use as a guideline when selecting the size of your chandelier.

Example: 14' + 20' = 34' Converted to inches = 34"
Correct Size Chandelier = 34" Diameter

If the resulting measurement (room length + width, converted to inches) seems inappropriate due to the size of your table, size your chandelier three quarters the width of your table.

In most cases, the bottom of your chandelier should sit approximately 30"-32" above the table top.

sizing a chandelier FOR YOUR FOYER

When determining whether to hang a flush, semi-flush, or multi-tiered chandelier in your foyer, be advised that the bottom of the fixture should be at least 7' from the floor.

For two-story foyers, if there is a window above the front door, center the chandelier so it can be seen from outside.

If your foyer is extra-large, you may also want to add sconces. Sconces should be installed 60" from the floor and 6'-8' apart.



TO MAKE SURE YOUR CHANDELIER IS THE RIGHT SIZE FOR THE ROOM IN WHICH IT WILL HANG, CONSIDER THE FOLLOWING:

1. How high is your ceiling?
Taller ceilings demand larger fixtures.
2. What is the size and shape of your table? Island?
The chandelier should complement, not overpower, anything you plan to suspend it over.
3. How big is the room you are trying to illuminate?
Again, be sure the chandelier is not too big or too small for the room.
4. What is the form and design of the chandelier?
Light, airy fixtures tend to look larger.

PIEDMONT™

Finish Brushed Nickel

Details Cast ball detailing; forged metal bobesches; Brushed Nickel candle sleeves



3748 BN





3745 BN



3742 BN



3740 BN



3746 BN

PIEDMONT

Brushed Nickel (BN)

ITEM	WIDTH/DIA.	HEIGHT	EXT.	TOP TO OUTLET	BACK PLATE/CANOPY	WIRE/CHAIN	STEMS INCLUDED	BULBS	AVAILABLE FINISHES
3740 BN	4½" W	9½"	5¼"	6½"	4½" W, 8" H Back Plate			1-60w Cand.	BN
3742 BN	11" W	9"	5¼"	5"	4½" W, 8" H Back Plate			2-60w Cand.	BN
3745 BN	24½" Dia.	14", 50¾" Max.*			5" Dia. Canopy	10' Wire	1-4", 1-6", 1-12", 1-24"	5-60w Cand.	BN
3746 BN	27¼" Dia.	14", 50¾" Max.*			5" Dia. Canopy	10' Wire	1-4", 1-6", 1-12", 1-24"	6-60w Cand.	BN
3748 BN	30¼" Dia.	18¼", 52½" Max.*			5" Dia. Canopy	10' Wire	1-4", 1-6", 1-12", 1-24"	9-60w Cand.	BN
6212 BN	⅝" Dia.	12" (stem)							BN

*Maximum achievable height with stems included. Additional stems available, see above.

MIDTOWN™

Finish Brushed Nickel
Glass Multi-faceted etched
Details Over-scaled center columns;
step transition glass holders



4978 BN





4971 BN



4972 BN 



4970 BN



4976 BN



4975 BN

MIDTOWN

Brushed Nickel (BN)

ITEM	WIDTH/DIA.	HEIGHT	EXT.	DEPTH	TOP TO OUTLET	BACK PLATE/CANOPY	WIRE/CHAIN	STEMS INCLUDED	BULBS	AVAILABLE FINISHES
4970 BN	5" W	8"	6¼"		4"	5" W, 8" H Back Plate			1-100w Med.	BN
4971 BN	18" Dia.	11¼"				6" Dia. Canopy			3-100w Med.	BN
4972 BN	18" Dia.	19½"				6" Dia. Canopy	12', 10'		3-100w Med.	BN
4975 BN	24" Dia.	22¼"				6" Dia. Canopy	6', 5'		5-100w Med.	BN
4976 BN	28" Dia.	24"				6" Dia. Canopy	6', 5'		6-100w Med.	BN
4978 BN	32" Dia.	29"				6" Dia. Canopy	12', 10'		9-100w Med.	BN

MERIDIAN™

Finish Brushed Nickel
Glass Thick faceted clear inside etched
Details Low profile ½" thick glass
See also Meridian bath, pages 190-191



3878 BN





MERIDIAN

Brushed Nickel (BN)

ITEM	WIDTH/DIA.	HEIGHT	EXT.	DEPTH	TOP TO OUTLET	BACK PLATE/CANOPY	WIRE/CHAIN	STEMS INCLUDED	BULBS	AVAILABLE FINISHES
3870 BN	5" W	11 1/4"	6 1/2"		4"	4 1/2" W, 8" H Back Plate			1-60w G9**	BN
3871 BN	16" Dia.	12 1/4"				5 1/2" Dia. Canopy			3-60w G9**	BN
3872 BN	20" Dia.	23", 54 1/2" Max.*				5 1/2" Dia. Canopy	10' Wire	1-6", 2-12"	3-100w Med.	BN
3873 BN	24" Dia.	18 1/2", 51" Max.*				5 1/2" Dia. Canopy	10' Wire	1-6", 2-12"	3-60w G9**	BN
3874 BN	44" W	20", 51 3/4" Max.*		7 1/2"		5 1/2" Dia. Canopy	10' Wire	1-6", 2-12"	4-60w G9**	BN
3875 BN	27" Dia.	18 1/2", 50 3/4" Max.*				5 1/2" Dia. Canopy	10' Wire	1-6", 2-12"	5-60w G9**	BN
3877 BN	7 1/2" Dia.	4 1/4", 36 3/4" Max.*				6" Dia. Canopy	10' Wire	1-6", 2-12"	1-60w G-9**	BN
3878 BN	34" Dia.	27", 98 1/4" Max.*				5 1/2" Dia. Canopy	12', 10'		9-60w G9**	BN
5590 BN	5" W	8"	6 1/2"		4"	4 1/2" W, 8" H Back Plate			1-60w G9**	BN, CM
4312 BN	1/2" Dia.	12" (stem, 3877 BN only)								BN
4512 BN	5/8" Dia.	12" (stem)								BN

*Maximum achievable height with stems (or stems and chain) included. Additional stems available, see above. **G9 halogen bulbs included.

ASHBURY™

Finish Chrome
Glass Etched opal
Details Faceted crystal bobesches
See also Ashbury bath, page 203



4088 CM





ASHBURY		Chrome (CM)								
ITEM	WIDTH/DIA.	HEIGHT	EXT.	DEPTH	TOP TO OUTLET	BACK PLATE/CANOPY	WIRE/CHAIN	STEMS INCLUDED	BULBS	AVAILABLE FINISHES
4083 CM	22½" Dia.	17"				5½" Dia. Canopy	6', 5'		3-60w G9**	CM
4085 CM	28¾" Dia.	21¾"				5½" Dia. Canopy	6', 5'		5-60w G9**	CM
4086 CM	48" W	22¾"		7½"		4½" W, 13¼" L Canopy	6', 5'		5-60w G9**	CM
4087 CM	5½" Dia.	10¼", 42½" Max.*				5½" Dia. Canopy	10' Wire	1-6", 2-12"	1-100w Med.	CM
4088 CM	38" Dia.	28"				5½" Dia. Canopy	12', 10'		9-60w G9**	CM
5700 CM	6" W	8"	7¾"		4"	4¾" W, 8" H Back Plate			1-60w G9**	CM
4312 CM	½" Dia.	12" (stem)								CM

*Maximum achievable height with stems included. Additional stems available, see above. **G9 halogen bulbs included.

TIDES™

- Finish Chrome
- Glass Hand-blown swirled optic (outer glass); etched opal (inner glass)
- Details Black chrome cast ball accents



4788 CM





4785 CM



4780 CM



4784 CM

TIDES		Chrome (CM)								
ITEM	WIDTH/DIA.	HEIGHT	EXT.	DEPTH	TOP TO OUTLET	BACK PLATE/CANOPY	WIRE/CHAIN	STEMS INCLUDED	BULBS	AVAILABLE FINISHES
4780 CM	4½" W	12"	6½"		8"	4½" W, 8" H Back Plate			1-60w Cand.	CM
4784 CM	35" W	23¼"		22½"		4½" W, 6¾" L Canopy	6', 5'		8-60w Cand.	CM
4785 CM	25¼" Dia.	28"				6½" Dia. Canopy	6', 5'		5-60w Cand.	CM
4788 CM	34" Dia.	32½"				6½" Dia. Canopy	12', 10'		9-60w Cand.	CM

CHANDON™

Finish Sterling
Glass Clear optic
Details Solid crystal center column and finials;
Sterling finished candle sleeves



4698 SR





4693 SR 



4690 SR



4696 SR

CHANDON

Sterling (SR)

ITEM	WIDTH/DIA.	HEIGHT	EXT.	DEPTH	TOP TO OUTLET	BACK PLATE/CANOPY	WIRE/CHAIN	STEMS INCLUDED	BULBS	AVAILABLE FINISHES
4690 SR	5¾" W	11½"	8½"		4¾"	4¼" W, 9" H Back Plate			1-60w Cand.	SR
4693 SR	21" Dia.	21", 23**				6¼" Dia. Canopy	6', 5'		3-60w Cand.	SR
4696 SR	28" Dia.	31"				6¼" Dia. Canopy	6', 5'		6-60w Cand.	SR
4698 SR	32" Dia.	31"				6¼" Dia. Canopy	12', 10'		9-60w Cand.	SR

*Height when hung with chain (includes loop).

BLOOM™

Finish Polished Antique Nickel
Glass Scalloped inside etched
Details Cast detailing
See also Bloom bath, page 231



4379 PL





BLOOM		Polished Antique Nickel (PL)								
ITEM	WIDTH/DIA.	HEIGHT	EXT.	DEPTH	TOP TO OUTLET	BACK PLATE/CANOPY	WIRE/CHAIN	STEMS INCLUDED	BULBS	AVAILABLE FINISHES
4371 PL	15" Dia.	8½"							2-60w Med.	PL
4373 PL	23" Dia.	19½"				7" Dia. Canopy	6', 5'		3-100w Med.	PL
4374 PL	20" Dia.	26½"				7" Dia. Canopy	12', 10'		3-100w Med.	PL
4375 PL	26" Dia.	24"				7" Dia. Canopy	6', 5'		5-100w Med.	PL
4377 PL	6¾" Dia.	8", 41¾" Max.*				7" Dia. Canopy	10' Wire	1-6", 2-12"	1-100w Med.	PL
4378 PL	31½" Dia.	30"				7" Dia. Canopy	12', 10'		9-75w Med.	PL
4379 PL	41" Dia.	41½"				7" Dia. Canopy	12', 10'		18-40w Med.	PL
5870 PL	6¾" W	9"	8"		4½"	5" W, 9" H Back Plate			1-100w Med.	PL
4312 PL	½" Dia.	12" (stem)								PL

*Maximum achievable height with stems included. Additional stems available, see above.

EASTON™

Finish Polished Antique Nickel
Glass Etched opal
Details Decorative trim rings on glass



3988 PL





3981 PL



3982 PL 



3980 PL



3987 PL



3985 PL



3983 PL

EASTON

Polished Antique Nickel (PL)

ITEM	WIDTH/DIA.	HEIGHT	EXT.	DEPTH	TOP TO OUTLET	BACK PLATE/CANOPY	WIRE/CHAIN	STEMS INCLUDED	BULBS	AVAILABLE FINISHES
3980 PL	5" W	11"	7¼"		4¾"	5" W, 8¾" H Back Plate			1-100w Med.	PL
3981 PL	16¼" Dia.	14¼"				6½" Dia. Canopy			3-100w Med.	PL
3982 PL	20¼" Dia.	27½"				5¼" Dia. Canopy	12', 10'		3-100w Med.	PL
3983 PL	22" Dia.	19¼"				5¼" Dia. Canopy	6', 5'		3-100w Med.	PL
3985 PL	26" Dia.	25½"				5¼" Dia. Canopy	6', 5'		5-100w Med.	PL
3987 PL	5" Dia.	6¾", 39¾" Max.*				5¼" Dia. Canopy	10' Wire	1-6", 2-12"	1-100w Med.	PL
3988 PL	32" Dia.	35½"				5¼" Dia. Canopy	12', 10'		9-100w Med.	PL
4312 PL	½" Dia.	12" (stem)								PL

*Maximum achievable height with stems included. Additional stems available, see above.

SUSSEX™

Finish Brushed Nickel
Shades White fabric hard-back
Details Clear glass casing on center columns and finials



4799 BN





4798 BN



4790 BN



4792 BN



4900 BN 



4795 BN

SUSSEX

Brushed Nickel (BN)

ITEM	WIDTH/DIA.	HEIGHT	EXT.	DEPTH	TOP TO OUTLET	BACK PLATE/CANOPY	WIRE/CHAIN	STEMS INCLUDED	BULBS	AVAILABLE FINISHES
4790 BN	4½" W	17¾"	6¾"		10¾"	4½" W, 14" H Back Plate			1-60w Cand.	BN, EZ
4792 BN	15½" W	15¾"	6¾"		8¾"	4½" W, 14" H Back Plate			2-60w Cand.	BN, EZ
4795 BN	26" Dia.	24¾"				6¾" Dia. Canopy	6', 5'		5-60w Cand.	BN, EZ
4798 BN	32" Dia.	34½"				6¾" Dia. Canopy	12', 10'		9-60w Cand.	BN, EZ
4799 BN	47" Dia.	44¾"				6¾" Dia. Canopy	12', 10'		15-40w Cand.	BN, EZ
4900 BN	14" W	14"	4"		7"	4½" W, 14" H Back Plate			2-60w Cand.	BN, EZ



4797 BN



4791 BN



4794 BN



4796 BN



4793 BN

SUSSEX

Brushed Nickel (BN)

Item	Width/Dia.	Height	Ext.	Depth	Top to Outlet	Back Plate/Canopy	Wire/Chain	Stems Included	Bulbs	Available Finishes
4791 BN	16" Dia.	15"				6¾" Dia. Canopy			3-75w Med.	BN, EZ
4793 BN	16" Dia.	19¼"				6¾" Dia. Canopy	6', 5'		3-60w Cand.	BN, EZ
4794 BN	22" Dia.	26¾"				6¾" Dia. Canopy	12', 10'		3-75w Med.	BN, EZ
4796 BN	36¾" W	25"		22¾"		4½" W, 14" L Canopy	6', 5'		6-60w Cand.	BN, EZ
4797 BN	23" Dia.	24"				6½" Dia. Canopy	12', 10'		4-60w Cand.	BN, EZ

SUSSEX™

Finish English Bronze
Shades Ivory fabric hard-back
Details Clear glass casing on center columns and finials



4799 EZ





4798 EZ



4790 EZ



4792 EZ



4900 EZ 



4795 EZ

SUSSEX

English Bronze (EZ)

ITEM	WIDTH/DIA.	HEIGHT	EXT.	DEPTH	TOP TO OUTLET	BACK PLATE/CANOPY	WIRE/CHAIN	STEMS INCLUDED	BULBS	AVAILABLE FINISHES
4790 EZ	4½" W	17¾"	6¾"		10¾"	4½" W, 14" H Back Plate			1-60w Cand.	BN, EZ
4792 EZ	15½" W	15¾"	6¾"		8¾"	4½" W, 14" H Back Plate			2-60w Cand.	BN, EZ
4795 EZ	26" Dia.	24¾"				6¾" Dia. Canopy	6', 5'		5-60w Cand.	BN, EZ
4798 EZ	32" Dia.	34½"				6¾" Dia. Canopy	12', 10'		9-60w Cand.	BN, EZ
4799 EZ	47" Dia.	44¾"				6¾" Dia. Canopy	12', 10'		15-40w Cand.	BN, EZ
4900 EZ	14" W	14"	4"		7"	4½" W, 14" H Back Plate			2-60w Cand.	BN, EZ



4797 EZ



4791 EZ



4794 EZ



4796 EZ



4793 EZ

SUSSEX

English Bronze (EZ)

Item	Width/Dia.	Height	Ext.	Depth	Top to Outlet	Back Plate/Canopy	Wire/Chain	Stems Included	Bulbs	Available Finishes
4791 EZ	16" Dia.	15"				6¾" Dia. Canopy			3-75w Med.	BN, EZ
4793 EZ	16" Dia.	19¼"				6¾" Dia. Canopy	6', 5'		3-60w Cand.	BN, EZ
4794 EZ	22" Dia.	26¾"				6¾" Dia. Canopy	12', 10'		3-75w Med.	BN, EZ
4796 EZ	36¾" W	25"		22¾"		4½" W, 14" L Canopy	6', 5'		6-60w Cand.	BN, EZ
4797 EZ	23" Dia.	24"				6½" Dia. Canopy	12', 10'		4-60w Cand.	BN, EZ

HAMPTON™

Finish Antique Nickel
Shades Off-white linen hard-back
Details Decorative etched acrylic
 bottom lenses



3206 AN 





3211 AN



3202 AN



3210 AN



3205 AN



3204 AN 



3203 AN 

HAMPTON

Antique Nickel (AN)

ITEM	WIDTH/DIA.	HEIGHT	EXT.	DEPTH	TOP TO OUTLET	BACK PLATE/CANOPY	WIRE/CHAIN	STEMS INCLUDED	BULBS	AVAILABLE FINISHES
3202 AN	15" W	12"	5/2"		4"	4 1/2" W, 12" H Back Plate			2-60w Cand.	AN, BR
3203 AN	20" Dia.	26 1/2"				5" Dia. Canopy	12', 5'		3-60w Med.	AN, BR
3204 AN	26" Dia.	30 3/4"				5" Dia. Canopy	12', 5'		3-100w Med.	AN, BR
3205 AN	16" Dia.	32 3/4"				5" Dia. Canopy	12', 10'		3-60w Med.	AN, BR
3206 AN	30" Dia.	33"				5" Dia. Canopy	12', 10'		3-100w Med.	AN, BR
3210 AN	6 3/4" W	12"	8 1/4"		6"	4 3/4" W, 12" H Back Plate			1-100w Med.	AN, BR
3211 AN	26" Dia.	14 1/2"				15 3/4" Dia. Canopy			3-100w Med.	AN, BR



HAMPTON

Antique Nickel (AN)

ITEM	WIDTH/DIA.	HEIGHT	EXT.	DEPTH	TOP TO OUTLET	BACK PLATE/CANOPY	WIRE/CHAIN	STEMS INCLUDED	BULBS	AVAILABLE FINISHES
3200 AN	15" Dia.	11¾"				9¾" Dia. Canopy			3-60w Med.	AN, BR
3201 AN	20" Dia.	12"				11¾" Dia. Canopy			3-75w Med.	AN, BR
3207 AN	7" Dia.	11¾", 44" Max.*				5" Dia. Canopy	10' Wire	1-6", 2-12"	1-100w Med.	AN, BR
3208 AN	40" W	31"		18"		4½" W, 7" L Canopy	12', 5'		4-100w Med.	AN, BR
3209 AN	24¾" Dia.	24½"				5" Dia. Canopy	6', 5'		4-100w Med.	AN, BR
3214 AN	29" W	24"				5" Dia. Canopy	10', 12'		4-100w Med.	AN, BR
4312 AN	½" Dia.	12" (stem)								AN, BR

*Maximum achievable height with stems included. Additional stems available, see above.

HAMPTON™

Finish Brushed Bronze
Shades Off-white linen hard-back
Details Decorative etched acrylic
bottom lenses



3206 BR 





3210 BR

3202 BR

3211 BR

3205 BR

3203 BR

3204 BR

HAMPTON

Brushed Bronze (BR)

ITEM	WIDTH/DIA.	HEIGHT	EXT.	DEPTH	TOP TO OUTLET	BACK PLATE/CANOPY	WIRE/CHAIN	STEMS INCLUDED	BULBS	AVAILABLE FINISHES
3202 BR	15" W	12"	5½"		4"	4½" W, 12" H Back Plate			2-60w Cand.	AN, BR
3203 BR	20" Dia.	26½"				5" Dia. Canopy	12', 5'		3-60w Med.	AN, BR
3204 BR	26" Dia.	30¼"				5" Dia. Canopy	12', 5'		3-100w Med.	AN, BR
3205 BR	16" Dia.	32¾"				5" Dia. Canopy	12', 10'		3-60w Med.	AN, BR
3206 BR	30" Dia.	33"				5" Dia. Canopy	12', 10'		3-100w Med.	AN, BR
3210 BR	6¾" W	12"	8¼"		6"	4¾" W, 12" H Back Plate			1-100w Med.	AN, BR
3211 BR	26" Dia.	14½"				15¾" Dia. Canopy			3-100w Med.	AN, BR



3201 BR

3200 BR

3208 BR

3207 BR

3209 BR

3214 BR

HAMPTON

Brushed Bronze (BR)

ITEM	WIDTH/DIA.	HEIGHT	EXT.	DEPTH	TOP TO OUTLET	BACK PLATE/CANOPY	WIRE/CHAIN	STEMS INCLUDED	BULBS	AVAILABLE FINISHES
3200 BR	15" Dia.	11¾"				9¾" Dia. Canopy			3-60w Med.	AN, BR
3201 BR	20" Dia.	12"				11¾" Dia. Canopy			3-75w Med.	AN, BR
3207 BR	7" Dia.	11¾", 44" Max.*				5" Dia. Canopy	10' Wire	1-6", 2-12"	1-100w Med.	AN, BR
3208 BR	40" W	31"		18"		4½" W, 7" L Canopy	12', 5'		4-100w Med.	AN, BR
3209 BR	24¾" Dia.	24½"				5" Dia. Canopy	6', 5'		4-100w Med.	AN, BR
3214 BR	29" W	24"				5" Dia. Canopy	10', 12'		4-100w Med.	AN, BR
4312 BR	½" Dia.	12" (stem)								AN, BR

*Maximum achievable height with stems included. Additional stems available, see above.

CIRRUS™

- Finish** Brushed Nickel
Shades Ivory fabric hard-back
Details Decorative etched acrylic bottom lenses; removable decorative canopy on 3804 BN and 3805 BN



3806 BN 





CIRRUS

Brushed Nickel (BN)

ITEM	WIDTH/DIA.	HEIGHT	EXT.	DEPTH	TOP TO OUTLET	BACK PLATE/CANOPY	WIRE/CHAIN	STEMS INCLUDED	BULBS	AVAILABLE FINISHES
3800 BN	15" W	6½"	4"		3¼"	13¼" W, 5½" H Back Plate			2-60w Cand.	BN
3802 BN	36" W	11½", 54" Max.**		23"		4¾" W, 16½" L Canopy	10' Wire	2-4", 2-6", 2-12", 2-24"	6-100w Med.	BN
3804 BN	20" W	12", 54" Max.**				5" Dia. Canopy	10' Wire	1-4", 1-6", 1-12", 1-24"	4-60w Med.	BN
3805 BN	28" W	12", 54" Max.**				5" Dia. Canopy	10' Wire	1-4", 1-6", 1-12", 1-24"	4-75w Med.	BN
3806 BN	48" W	11½", 54" Max.**		8½"		4¾" W, 16½" L Canopy	10' Wire	2-4", 2-6", 2-12", 2-24"	6-75w Med.	BN
6212 BN	⅝" Dia.	12" (stem)								BN

*Minimum height when mounting semi-flush to the ceiling (4" stems must be used). **Maximum achievable height with stems included. Additional stems available, see above.

HATHAWAY™

Finish Antique Nickel or Olde Bronze
Glass Etched (Antique Nickel);
 etched amber (Olde Bronze)
Details Forged uprights and ring detail



3224 AN 



3224 OB 





3220 AN



3221 AN



3220 OB



3222 AN 



3221 OB



3222 OB 

HATHAWAY

Antique Nickel (AN), Olde Bronze (OB)

ITEM	WIDTH/DIA.	HEIGHT	EXT.	DEPTH	TOP TO OUTLET	BACK PLATE/CANOPY	WIRE/CHAIN	STEMS INCLUDED	BULBS	AVAILABLE FINISHES
3220 AN	16" Dia.	11¾"				5¾" Dia. Canopy			3-100w Med.	AN, OB
3220 OB	16" Dia.	11¾"				5¾" Dia. Canopy			3-100w Med.	AN, OB
3221 AN	20¾" Dia.	12¼"				5¾" Dia. Canopy			4-100w Med.	AN, OB
3221 OB	20¾" Dia.	12¼"				5¾" Dia. Canopy			4-100w Med.	AN, OB
3222 AN	20¾" Dia.	26½", 59½" Max.*				5" Dia. Canopy	10' Wire	1-6", 2-12"	4-100w Med.	AN, OB
3222 OB	20¾" Dia.	26½", 59½" Max.*				5" Dia. Canopy	10' Wire	1-6", 2-12"	4-100w Med.	AN, OB
3224 AN	26¾" Dia.	29¼", 62¼" Max.*				5" Dia. Canopy	10' Wire	1-6", 2-12"	5-100w Med.	AN, OB
3224 OB	26¾" Dia.	29¼", 62¼" Max.*				5" Dia. Canopy	10' Wire	1-6", 2-12"	5-100w Med.	AN, OB
4512 AN	¾" Dia.	12" (stem)								AN, OB
4512 OB	¾" Dia.	12" (stem)								AN, OB

*Maximum achievable height with stems included. Additional stems available, see above.

BOLLA™

Finish Brushed Nickel
Glass Etched opal
Details Heavy cast ball transition detail
See also Bolla bath, pages 236-238
Bolla outdoor, pages 300-303



4659 BN 





4653 BN



4655 BN



4650 BN



4656 BN



4657 BN

BOLLA

Brushed Nickel (BN)

ITEM	WIDTH/DIA.	HEIGHT	EXT.	DEPTH	TOP TO OUTLET	BACK PLATE/CANOPY	WIRE/CHAIN	STEMS INCLUDED	BULBS	AVAILABLE FINISHES
4650 BN	7¾" W	8½"	8¾"		3½"	6" W, 7½" H Back Plate			1-100w Med.	BN, BR, OB
4653 BN	22½" Dia.	18"				6" Dia. Canopy	6', 5'		3-100w Med.	BN, BR, OB
4655 BN	24" Dia.	24"				6" Dia. Canopy	6', 5'		5-100w Med.	BN, BR, OB
4656 BN	29" Dia.	29"				6" Dia. Canopy	6', 5'		6-100w Med.	BN, BR, OB
4657 BN	35" Dia.	37½"				6" Dia. Canopy	12', 10'		9-100w Med.	BN, BR, OB
4659 BN	48" Dia.	48½"				6" Dia. Canopy	12', 10'		18-60w Med.	BN, BR, OB



BOLLA

Brushed Nickel (BN)

ITEM	WIDTH/DIA.	HEIGHT	EXT.	DEPTH	TOP TO OUTLET	BACK PLATE/CANOPY	WIRE/CHAIN	STEMS INCLUDED	BULBS	AVAILABLE FINISHES
4652 BN	23¼" Dia.	26½"				6" Dia. Canopy	6', 5'		3-100w Med.	BN, BR, OB
4661 BN	15½" Dia.	8¼", 48" Max*				6" Dia. Canopy	10', 5'	3-12"	1-100w Med.	BN, BR, OB
4662 BN	44¼" W	26½"		15½"		6" Dia. Canopy	6', 5'		2-100w Med.	BN, BR, OB
4666 BN	56" W	25¼"		15½"		6" Dia. Canopy	6', 5'		3-100w Med.	BN, BR, OB
4667 BN	7¾" Dia.	7¼", 39½" Max.*				5¼" Dia. Canopy	10'	1-6", 2-12"	1-100w Med.	BN, BR, OB
4312 BN	½" Dia.	12" (stem)								BN, BR, OB

*Maximum achievable height with stems included. Additional stems available, see above.



4660 BN



4669 BN



4651 BN



4665 BN



4664 BN 



4663 BN

BOLLA

Brushed Nickel (BN)

ITEM	WIDTH/DIA.	HEIGHT	EXT.	DEPTH	TOP TO OUTLET	BACK PLATE/CANOPY	WIRE/CHAIN	STEMS INCLUDED	BULBS	AVAILABLE FINISHES
4651 BN	19¼" Dia.	14"				6" Dia. Canopy			2-100w Med.	BN, BR, OB
4660 BN	16¾" Dia.	8"				5" Dia. Canopy			2-75w Med.	BN, BR, OB
4663 BN	16" Dia.	28¾"				6" Dia. Canopy	6', 5'		3-60w Cand.	BN, BR, OB
4664 BN	30" Dia.	32"				6" Dia. Canopy	12', 10'		4-75w Med.	BN, BR, OB
4665 BN	18" Dia.	44"				6" Dia. Canopy	12', 10'		6-60w Cand.	BN, BR, OB
4669 BN	23¼" Dia.	16"				6" Dia. Canopy			3-100w Med.	BN, BR, OB

BOLLA™

Finish Olde Bronze
Glass Light amber seedy
Details Heavy cast ball transition detail
See also Bolla bath, pages 236-238
Bolla outdoor, pages 300-303



4659 OB 





4653 OB



4655 OB



4650 OB



4656 OB



4657 OB

BOLLA

Olde Bronze (OB)

ITEM	WIDTH/DIA.	HEIGHT	EXT.	DEPTH	TOP TO OUTLET	BACK PLATE/CANOPY	WIRE/CHAIN	STEMS INCLUDED	BULBS	AVAILABLE FINISHES
4650 OB	7¾" W	8½"	8¾"		3½"	6" W, 7½" H Back Plate			1-100w Med.	BN, BR, OB
4653 OB	22½" Dia.	18"				6" Dia. Canopy	6', 5'		3-100w Med.	BN, BR, OB
4655 OB	24" Dia.	24"				6" Dia. Canopy	6', 5'		5-100w Med.	BN, BR, OB
4656 OB	29" Dia.	29"				6" Dia. Canopy	6', 5'		6-100w Med.	BN, BR, OB
4657 OB	35" Dia.	37½"				6" Dia. Canopy	12', 10"		9-100w Med.	BN, BR, OB
4659 OB	48" Dia.	48½"				6" Dia. Canopy	12', 10"		18-60w Med.	BN, BR, OB



BOLLA

Olde Bronze (OB)

ITEM	WIDTH/DIA.	HEIGHT	EXT.	DEPTH	TOP TO OUTLET	BACK PLATE/CANOPY	WIRE/CHAIN	STEMS INCLUDED	BULBS	AVAILABLE FINISHES
4652 OB	23¼" Dia.	26½"				6" Dia. Canopy	6', 5'		3-100w Med.	BN, BR, OB
4661 OB	15½" Dia.	8¼", 48" Max*				6" Dia. Canopy	10', 5'	3-12"	1-100w Med.	BN, BR, OB
4662 OB	44¼" W	26½"		15½"		6" Dia. Canopy	6', 5'		2-100w Med.	BN, BR, OB
4666 OB	56" W	25¼"		15½"		6" Dia. Canopy	6', 5'		3-100w Med.	BN, BR, OB
4667 OB	7¾" Dia.	7¼", 39½" Max.*				5¼" Dia. Canopy	10'	1-6", 2-12"	1-100w Med.	BN, BR, OB
4312 OB	½" Dia.	12" (stem)								BN, BR, OB

*Maximum achievable height with stems included. Additional stems available, see above.



4660 OB



4669 OB



4651 OB



4665 OB



4664 OB 



4663 OB

BOLLA

Olde Bronze (OB)

ITEM	WIDTH/DIA.	HEIGHT	EXT.	DEPTH	TOP TO OUTLET	BACK PLATE/CANOPY	WIRE/CHAIN	STEMS INCLUDED	BULBS	AVAILABLE FINISHES
4651 OB	19¼" Dia.	14"				6" Dia. Canopy			2-100w Med.	BN, BR, OB
4660 OB	16¾" Dia.	8"				5" Dia. Canopy			2-75w Med.	BN, BR, OB
4663 OB	16" Dia.	28¾"				6" Dia. Canopy	6', 5'		3-60w Cand.	BN, BR, OB
4664 OB	30" Dia.	32"				6" Dia. Canopy	12', 10'		4-75w Med.	BN, BR, OB
4665 OB	18" Dia.	44"				6" Dia. Canopy	12', 10'		6-60w Cand.	BN, BR, OB
4669 OB	23¼" Dia.	16"				6" Dia. Canopy			3-100w Med.	BN, BR, OB

BOLLA™

Finish Brushed Bronze
Glass Light amber seedy
Details Heavy cast ball transition detail
See also Bolla bath, pages 236-238
Bolla outdoor, pages 300-303



4659 BR 





4653 BR



4655 BR



4650 BR



4656 BR



4657 BR

BOLLA

Brushed Bronze (BR)

ITEM	WIDTH/DIA.	HEIGHT	EXT.	DEPTH	TOP TO OUTLET	BACK PLATE/CANOPY	WIRE/CHAIN	STEMS INCLUDED	BULBS	AVAILABLE FINISHES
4650 BR	7¾" W	8½"	8¾"		3½"	6" W, 7½" H Back Plate			1-100w Med.	BN, BR, OB
4653 BR	22½" Dia.	18"				6" Dia. Canopy	6', 5'		3-100w Med.	BN, BR, OB
4655 BR	24" Dia.	24"				6" Dia. Canopy	6', 5'		5-100w Med.	BN, BR, OB
4656 BR	29" Dia.	29"				6" Dia. Canopy	6', 5'		6-100w Med.	BN, BR, OB
4657 BR	35" Dia.	37½"				6" Dia. Canopy	12', 10'		9-100w Med.	BN, BR, OB
4659 BR	48" Dia.	48½"				6" Dia. Canopy	12', 10'		18-60w Med.	BN, BR, OB



BOLLA		Brushed Bronze (BR)								
ITEM	WIDTH/DIA.	HEIGHT	EXT.	DEPTH	TOP TO OUTLET	BACK PLATE/CANOPY	WIRE/CHAIN	STEMS INCLUDED	BULBS	AVAILABLE FINISHES
4652 BR	23¼" Dia.	26½"				6" Dia. Canopy	6', 5'		3-100w Med.	BN, BR, OB
4661 BR	15½" Dia.	8¼", 48" Max*				6" Dia. Canopy	10', 5'	3-12"	1-100w Med.	BN, BR, OB
4662 BR	44¼" W	26½"		15½"		6" Dia. Canopy	6', 5'		2-100w Med.	BN, BR, OB
4666 BR	56" W	25¼"		15½"		6" Dia. Canopy	6', 5'		3-100w Med.	BN, BR, OB
4667 BR	7¾" Dia.	7¼", 39½" Max.*				5¼" Dia. Canopy	10'	1-6", 2-12"	1-100w Med.	BN, BR, OB
4312 BR	½" Dia.	12" (stem)								BN, BR, OB

*Maximum achievable height with stems included. Additional stems available, see above.



4660 BR



4669 BR



4651 BR



4665 BR



4664 BR 



4663 BR

BOLLA

Brushed Bronze (BR)

ITEM	WIDTH/DIA.	HEIGHT	EXT.	DEPTH	TOP TO OUTLET	BACK PLATE/CANOPY	WIRE/CHAIN	STEMS INCLUDED	BULBS	AVAILABLE FINISHES
4651 BR	19¼" Dia.	14"				6" Dia. Canopy			2-100w Med.	BN, BR, OB
4660 BR	16¾" Dia.	8"				5" Dia. Canopy			2-75w Med.	BN, BR, OB
4663 BR	16" Dia.	28¾"				6" Dia. Canopy	6', 5'		3-60w Cand.	BN, BR, OB
4664 BR	30" Dia.	32"				6" Dia. Canopy	12', 10'		4-75w Med.	BN, BR, OB
4665 BR	18" Dia.	44"				6" Dia. Canopy	12', 10'		6-60w Cand.	BN, BR, OB
4669 BR	23¼" Dia.	16"				6" Dia. Canopy			3-100w Med.	BN, BR, OB

VALLEY™

Finish Brushed Nickel
Glass Etched opal
Details Glass transitions from square on the bottom to round on the top



4708 BN





4701 BN



4704 BN 



4702 BN



4707 BN



4703 BN



4700 BN



4705 BN

VALLEY

Brushed Nickel (BN)

ITEM	WIDTH/DIA.	HEIGHT	EXT.	DEPTH	TOP TO OUTLET	BACK PLATE/CANOPY	WIRE/CHAIN	STEMS INCLUDED	BULBS	AVAILABLE FINISHES
4700 BN	5¼" W	21"	7¼"		10½"	4½" W, 4¾" H Back Plate			1-100w Med.	BN, VK
4701 BN	18½" Dia.	12¼"				5¼" Dia. Canopy			2-100w Med.	BN, VK
4702 BN	23" Dia.	13¾"				5½" Dia. Canopy			3-100w Med.	BN, VK
4703 BN	19" Dia.	27"				5¾" Dia. Canopy	6', 5'		3-100w Med.	BN, VK
4704 BN	23¾" Dia.	26½"				5¾" Dia. Canopy	12', 10'		3-100w Med.	BN, VK
4705 BN	27" Dia.	33¾"				5¾" Dia. Canopy	6', 5'		5-100w Med.	BN, VK
4707 BN	5¼" Dia.	12¼", 45¼" Max.*				5¾" Dia. Canopy	10' Wire	1-6", 2-12"	1-100w Med.	BN, VK
4708 BN	32" Dia.	37¼"				5¾" Dia. Canopy	12', 10'		9-75w Med.	BN, VK
4312 BN	½" Dia.	12" (stem)								BN, VK

*Maximum achievable height with stems included. Additional stems available, see above.

VALLEY™

Finish Vintage Black
Glass Amber iridescent
Details Glass transitions from square on the bottom to round on the top



4708 VK





4701 VK

4702 VK

4704 VK 

4707 VK

4703 VK

4700 VK

4705 VK

VALLEY

Vintage Black (VK)

ITEM	WIDTH/DIA.	HEIGHT	EXT.	DEPTH	TOP TO OUTLET	BACK PLATE/CANOPY	WIRE/CHAIN	STEMS INCLUDED	BULBS	AVAILABLE FINISHES
4700 VK	5¼" W	21"	7¼"	10½"		4½" W, 4¾" H Back Plate			1-100w Med.	BN, VK
4701 VK	18½" Dia.	12¼"				5¼" Dia. Canopy			2-100w Med.	BN, VK
4702 VK	23" Dia.	13¾"				5½" Dia. Canopy			3-100w Med.	BN, VK
4703 VK	19" Dia.	27"				5¾" Dia. Canopy	6', 5'		3-100w Med.	BN, VK
4704 VK	23¾" Dia.	26½"				5¾" Dia. Canopy	12', 10'		3-100w Med.	BN, VK
4705 VK	27" Dia.	33¾"				5¾" Dia. Canopy	6', 5'		5-100w Med.	BN, VK
4707 VK	5¼" Dia.	12¼", 45¼" Max.*				5¾" Dia. Canopy	10' Wire	1-6", 2-12"	1-100w Med.	BN, VK
4708 VK	32" Dia.	37¼"				5¾" Dia. Canopy	12', 10'		9-75w Med.	BN, VK
4312 VK	½" Dia.	12" (stem)								BN, VK

*Maximum achievable height with stems included. Additional stems available, see above.

PARKER™

Finish Buckeye Bronze
Glass Light etched amber linen
Details Decorative double arm construction



4439 KZ





PARKER		Buckeye Bronze (KZ)								
ITEM	WIDTH/DIA.	HEIGHT	EXT.	DEPTH	TOP TO OUTLET	BACK PLATE/CANOPY	WIRE/CHAIN	STEMS INCLUDED	BULBS	AVAILABLE FINISHES
4430 KZ	5¼" W	12"	6¼"		4"	5¼" W, 12" H Back Plate			1-100w Med.	KZ
4431 KZ	16" Dia.	12¾"				6" Dia. Canopy			2-100w Med.	KZ
4433 KZ	22" Dia.	23"				6" Dia. Canopy	6', 5'		3-100w Med.	KZ
4434 KZ	20" Dia.	24½"				6" Dia. Canopy	12', 10'		3-100w Med.	KZ
4436 KZ	26¼" Dia.	23½"				6" Dia. Canopy	6', 5'		6-100w Med.	KZ
4437 KZ	4¾" Dia.	14¼", 46½" Max.*				6" Dia. Canopy	10' Wire	1-6", 2-12"	1-100w Med.	KZ
4438 KZ	32¼" Dia.	32¾"				6" Dia. Canopy	12', 10'		9-75w Med.	KZ
4439 KZ	42¼" Dia.	34"				6" Dia. Canopy	12', 10'		12-60w Med.	KZ
4312 KZ	½" Dia.	12" (stem)								KZ

*Maximum achievable height with stems included. Additional stems available, see above.

BRANTLEY™

Finish Oil Rubbed Bronze
Glass Etched amber
Details Hexagonal castings; decorative
twin arm construction



4639 OZ





BRANTLEY

Oil Rubbed Bronze (OZ)

ITEM	WIDTH/DIA.	HEIGHT	EXT.	DEPTH	TOP TO OUTLET	BACK PLATE/CANOPY	WIRE/CHAIN	STEMS INCLUDED	BULBS	AVAILABLE FINISHES
4630 OZ	4¾" W	12¼"	8½"		7"	4¾" W, 10" H Back Plate			1-100w Med.	OZ, TB
4631 OZ	17" Dia.	7"							3-60w Med.	OZ, TB
4632 OZ	17" Dia.	10¾"				5" Dia. Canopy			3-100w Med.	OZ, TB
4633 OZ	22½" Dia.	22"				5" Dia. Canopy	6', 5'		3-100w Med.	OZ, TB
4636 OZ	29¾" Dia.	26¼"				5" Dia. Canopy	6', 5'		6-100w Med.	OZ, TB
4637 OZ	4¾" Dia.	15", 41¼" Max.*				5" Dia. Canopy	10' Wire	1-6", 2-12"	1-100w Med.	OZ, TB
4638 OZ	33¾" Dia.	32¾"				5" Dia. Canopy	12', 10'		9-75w Med.	OZ, TB
4639 OZ	43" Dia.	34"				5" Dia. Canopy	12', 10'		12-60w Med.	OZ, TB
4312 OZ	½" Dia.	12" (stem)								OZ, TB

*Maximum achievable height with stems included. Additional stems available, see above.

BRANTLEY™

Finish Textured Black
Glass Etched white
Details Hexagonal castings; decorative
twin arm construction



4639 TB





BRANTLEY		Textured Black (TB)								
ITEM	WIDTH/DIA.	HEIGHT	EXT.	DEPTH	TOP TO OUTLET	BACK PLATE/CANOPY	WIRE/CHAIN	STEMS INCLUDED	BULBS	AVAILABLE FINISHES
4630 TB	4¾" W	12¼"	8½"		7"	4¾" W, 10" H Back Plate			1-100w Med.	OZ, TB
4631 TB	17" Dia.	7"							3-60w Med.	OZ, TB
4632 TB	17" Dia.	10¾"				5" Dia. Canopy			3-100w Med.	OZ, TB
4633 TB	22½" Dia.	22"				5" Dia. Canopy	6', 5'		3-100w Med.	OZ, TB
4636 TB	29¾" Dia.	26¼"				5" Dia. Canopy	6', 5'		6-100w Med.	OZ, TB
4637 TB	4¾" Dia.	15", 41¼" Max.*				5" Dia. Canopy	10' Wire	1-6", 2-12"	1-100w Med.	OZ, TB
4638 TB	33¾" Dia.	32¾"				5" Dia. Canopy	12', 10'		9-75w Med.	OZ, TB
4639 TB	43" Dia.	34"				5" Dia. Canopy	12', 10'		12-60w Med.	OZ, TB
4312 TB	½" Dia.	12" (stem)								OZ, TB

*Maximum achievable height with stems included. Additional stems available, see above.

COOPER™

Finish Oil Rubbed Bronze with
Brushed Bronze accents

Glass Etched

Details Low profile glass; heavy
Brushed Bronze cast ball
transition detailing



4685 OZ





4681 OZ



4682 OZ



4684 OZ



4680 OZ

COOPER

Oil Rubbed Bronze (OZ)

ITEM	WIDTH/DIA.	HEIGHT	EXT.	TOP TO OUTLET	BACK PLATE/CANOPY	WIRE/CHAIN	STEMS INCLUDED	BULBS	AVAILABLE FINISHES
4680 OZ	10" W	8"	11¼"	4"	4¾" W, 8" H Back Plate			1-60w G9**	OZ
4681 OZ	18¼" Dia.	9"			5¼" Dia. Canopy			3-100w Med.	OZ
4682 OZ	23¼" Dia.	22½", 59½" Max.*			5¼" Dia. Canopy	10' Wire	1-4", 1-6", 1-12", 1-24"	4-100w Med.	OZ
4684 OZ	27¾" Dia.	16¾", 53¾" Max.*			5¼" Dia. Canopy	10' Wire	1-4", 1-6", 1-12", 1-24"	4-60w G9**	OZ
4685 OZ	34" Dia.	18¾", 55¾" Max.*			5¼" Dia. Canopy	10' Wire	1-4", 1-6", 1-12", 1-24"	5-60w G9**	OZ
6212 OZ	¾" Dia.	12" (stem)							OZ

*Maximum achievable height with stems included. Additional stems available, see above. **G9 halogen bulbs included.

MONDRIAN™

- Finish Buckeye Bronze
- Glass Copper foil bound glass panels
- Details Geometric shapes form a continuous pattern on glass



4576 KZ





MONDRIAN

Buckeye Bronze (KZ)

ITEM	WIDTH/DIA.	HEIGHT	EXT.	DEPTH	TOP TO OUTLET	BACK PLATE/CANOPY	WIRE/CHAIN	STEMS INCLUDED	BULBS	AVAILABLE FINISHES
4570 KZ	7" W	11"	4"		5½"	7" W, 10½" H Back Plate			2-60w Cand.	KZ
4571 KZ	16" W	12", 13¼**		16"		7" W Canopy	6', 5'		4-60w Cand.	KZ
4572 KZ	7" W	24"	4"		12"	7" W, 23" H Back Plate			3-60w Cand.	KZ
4574 KZ	14" W	26"		14"		7" W Canopy	6', 5'		4-60w Cand.	KZ
4575 KZ	36" W	24"		12"		4½" W, 12¼" L Canopy	6', 5'		5-60w Cand.	KZ
4576 KZ	14" W	42"		14"		7" W Canopy	12', 10'		12-60w Cand.	KZ
4577 KZ	7" W	11½", 43½" Max.**		7"		5" W Canopy	10' Wire	1-6", 2-12"	1-100w Med.	KZ
4312 KZ	½" Dia.	12" (stem)								KZ

*Height when hung with chain (includes loop). **Maximum achievable height with stems included. Additional stems available, see above.

STOWE™

- Finish Metro Copper
Glass Antique light scavo
Details Hand-forged iron work; finish features subtle red copper hues
See also Stowe bath, page 241



4728 MC



4729 MC 





4722 MC



4721 MC



4720 MC



4727 MC



4724 MC



4723 MC



4725 MC

STOWE

Metro Copper (MC)

ITEM	WIDTH/DIA.	HEIGHT	EXT.	DEPTH	TOP TO OUTLET	BACK PLATE/CANOPY	WIRE/CHAIN	STEMS INCLUDED	BULBS	AVAILABLE FINISHES
4720 MC	5" W	14"	6½"		6¾"	4" W, 7" H Back Plate			1-100w Med.	MC
4721 MC	15½" Dia.	6¾"							2-75w Med.	MC
4722 MC	18½" Dia.	17", 19"				7" Dia. Canopy	6', 5'		3-100w Med.	MC
4723 MC	18½" Dia.	16¾"				7" Dia. Canopy	6', 5'		3-100w Med.	MC
4724 MC	22" Dia.	24"				7" Dia. Canopy	12', 10'		3-75w Med.	MC
4725 MC	23" Dia.	22½"				7" Dia. Canopy	6', 5'		5-100w Med.	MC
4727 MC	5" Dia.	10½", 43¾" Max.**				7" Dia. Canopy	10' Wire	1-6", 2-12"	1-100w Med.	MC
4728 MC	30" Dia.	27½"				7" Dia. Canopy	12', 10'		9-75w Med.	MC
4729 MC	42" Dia.	36"				7" Dia. Canopy	12', 10'		15-60w Med.	MC
4312 MC	½" Dia.	12" (stem)								MC

*Height when hung with chain (includes loop). **Maximum achievable height with stems included. Additional stems available, see above.

THISTLEDOWN™

- Finish Victorian Bronze
Glass Amber linen
Details Industrial yoke-mount center stem design
See also Thistledown bath, page 242
Thistledown outdoor, pages 316-317
Thistledown landscape, page 410



4179 VZ 





THISTLEDOWN

Victorian Bronze (VZ)

ITEM	WIDTH/DIA.	HEIGHT	EXT.	DEPTH	TOP TO OUTLET	BACK PLATE/CANOPY	WIRE/CHAIN	STEMS INCLUDED	BULBS	AVAILABLE FINISHES
4170 VZ	15" Dia.	13"				5¾" Dia. Canopy			3-75w Med.	VZ
4171 VZ	15¼" Dia.	8"							3-60w Med.	VZ
4173 VZ	15¼" Dia.	23"				5¾" Dia. Canopy	6', 5'		3-100w Med.	VZ
4176 VZ	26½" Dia.	25½"				5¾" Dia. Canopy	6', 5'		6-100w Med.	VZ
4177 VZ	5¼" Dia.	10½", 43½" Max.*				5¾" Dia. Canopy	10' Wire	1-6", 2-12"	1-100w Med.	VZ
4178 VZ	30½" Dia.	39½"				5¾" Dia. Canopy	12', 10'		9-75w Med.	VZ
4179 VZ	41½" Dia.	50½"				5¾" Dia. Canopy	12', 10'		15-60w Med.	VZ
5680 VZ	5¾" W	12¼"	7¾"		9½"	5¾" Dia. Back Plate			1-100w Med.	VZ
4312 VZ	½" Dia.	12" (stem)								VZ

*Maximum achievable height with stems included. Additional stems available, see above.



4508 VZ



4505 VZ

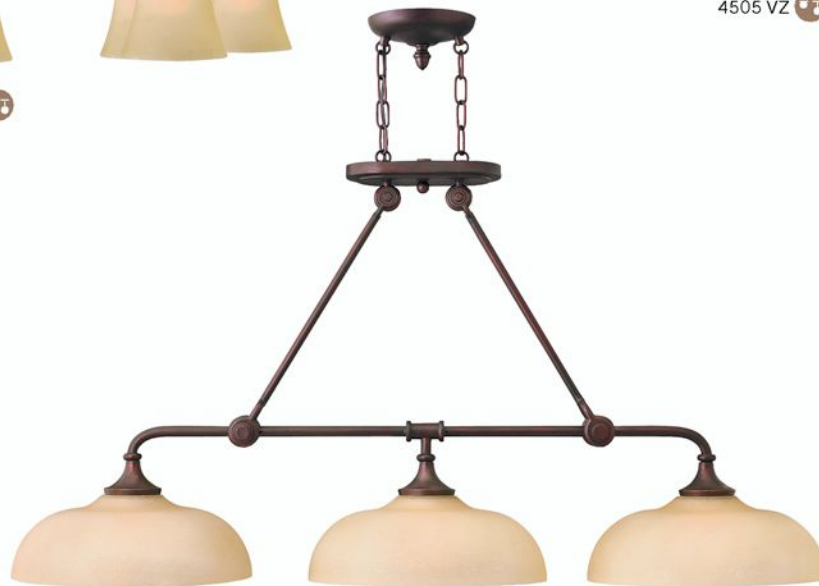

4174 VZ

THISTLEDOWN

Victorian Bronze (VZ)

ITEM	WIDTH/DIA.	HEIGHT	EXT.	DEPTH	TOP TO OUTLET	BACK PLATE/CANOPY	WIRE/CHAIN	STEMS INCLUDED	BULBS	AVAILABLE FINISHES
4174 VZ	47" W	24½"		13¾"		5¾" Dia. Canopy	6', 5'		3-100w Med.	VZ
4505 VZ	25" Dia.	34½", 38"				5" Dia. Canopy	6', 5'		5-100w Med.	VZ
4508 VZ	36" Dia.	45¼", 48½"				5" Dia. Canopy	12', 10'		8-100w Med.	VZ

*Height when hung with chain (includes loop).



MAYFLOWER™

Finish Olde Bronze
Glass Inside etched amber
Details Unique yoke-mount glass holders;
decorative cast tension adjustment
knob detailing



4168 OB





MAYFLOWER

Olde Bronze (OB)

ITEM	WIDTH/DIA.	HEIGHT	EXT.	DEPTH	TOP TO OUTLET	BACK PLATE/CANOPY	WIRE/CHAIN	STEMS INCLUDED	BULBS	AVAILABLE FINISHES
4151 OB	14" Dia.	9", 42½" Max.*				6" Dia. Canopy	10' Wire	1-6", 2-12"	1-100w Med.	OB
4161 OB	15" Dia.	12"				6" Dia. Canopy			3-75w Med.	OB
4162 OB	21" Dia.	28¾"				6" Dia. Canopy	12', 10'		3-100w Med.	OB
4163 OB	16" Dia.	17"				6" Dia. Canopy	6', 5'		3-100w Med.	OB
4165 OB	24" Dia.	21¾"				6" Dia. Canopy	6', 5'		5-100w Med.	OB
4166 OB	26" Dia.	24¾"				6" Dia. Canopy	6', 5'		6-100w Med.	OB
4167 OB	5" Dia.	8¼", 41¾" Max.*				6" Dia. Canopy	10' Wire	1-6", 2-12"	1-100w Med.	OB
4168 OB	32" Dia.	31"				6" Dia. Canopy	12', 10'		9-75w Med.	OB
5670 OB	5" W	10½"	6¾"		6½"	5" Dia. Back Plate			1-100w Med.	OB
4312 OB	½" Dia.	12" (stem, for 4167 OB)								OB
4512 OB	⅝" Dia.	12" (stem, for 4151 OB)								OB

*Maximum achievable height with stems included. Additional stems available, see above.

MIDDLEBURY™

Finish Forged Iron
Glass Speckled light etched amber
Details Low profile glass



3768 FI





3761 FI



3762 FI 



3760 FI



3763 FI



3765 FI

MIDDLEBURY

Forged Iron (FI)

ITEM	WIDTH/DIA.	HEIGHT	EXT.	DEPTH	TOP TO OUTLET	BACK PLATE/CANOPY	WIRE/CHAIN	STEMS INCLUDED	BULBS	AVAILABLE FINISHES
3760 FI	9½" W	12¾"	11"		5¼"	5" W, 9" H Back Plate			1-60w Cand.*	FI
3761 FI	17" Dia.	11½"				7¼" Dia. Canopy			3-100w Med.	FI
3762 FI	23½" Dia.	27¼"				6" Dia. Canopy	12', 10'		3-100w Med.	FI
3763 FI	26½" Dia.	23"				6" Dia. Canopy	6', 5'		3-60w Cand.*	FI
3765 FI	32½" Dia.	25½"				6" Dia. Canopy	6', 5'		5-60w Cand.*	FI
3768 FI	37¼" Dia.	29½"				7¼" Dia. Canopy	12', 10'		9-60w Cand.*	FI

*Recommend G16½ or 60w E-12 lamp – sold separately (0060W-E12).

YORKTOWN™

Finish Brushed Bronze
Details Antiqued candle sleeves with
Brushed Bronze candle chasers;
cast detailing



3628 BR





3620 BR



3625 BR



3626 BR



3622 BR

YORKTOWN

Brushed Bronze (BR)

ITEM	WIDTH/DIA.	HEIGHT	EXT.	DEPTH	TOP TO OUTLET	BACK PLATE/CANOPY	WIRE/CHAIN	STEMS INCLUDED	BULBS	AVAILABLE FINISHES
3620 BR	4¾" W	13"	4¾"		8"	4¾" W, 9" H Back Plate			1-60w Cand.	BR
3622 BR	13¾" W	15"	6½"		10½"	4¾" W, 9" H Back Plate			2-60w Cand.	BR
3625 BR	24" Dia.	25"				6" Dia. Canopy	6', 5'		5-60w Cand.	BR
3626 BR	28" Dia.	27"				6" Dia. Canopy	6', 5'		6-60w Cand.	BR
3628 BR	32" Dia.	29"				6" Dia. Canopy	12', 10'		9-60w Cand.	BR

CELLO™

Finish Antique Bronze
Glass Vintage faux alabaster
Details Finish features subtle rubbed
 antique highlights



4569 AT 





4563 AT



5450 AT



4561 AT



4564 AT 



4567 AT



4566 AT



4568 AT

CELLO

Antique Bronze (AT)

ITEM	WIDTH/DIA.	HEIGHT	EXT.	DEPTH	TOP TO OUTLET	BACK PLATE/CANOPY	WIRE/CHAIN	STEMS INCLUDED	BULBS	AVAILABLE FINISHES
4561 AT	19" Dia.	16"				6" Dia. Canopy			2-75w Med.	AT
4563 AT	22½" Dia.	21"				6" Dia. Canopy	6' 5'		3-100w Med.	AT
4564 AT	21" Dia.	25"				6" Dia. Canopy	12', 10'		3-100w Med.	AT
4566 AT	31¾" Dia.	24¾"				6" Dia. Canopy	6' 5'		6-100w Med.	AT
4567 AT	8½" Dia.	7", 40¾" Max.*				6" Dia. Canopy	10' Wire	1-6", 2-12"	1-100w Med.	AT
4568 AT	35¾" Dia.	32½"				6" Dia. Canopy	12', 10'		9-100w Med.	AT
4569 AT	47" Dia.	43"				6" Dia. Canopy	12', 10'		15-60w Med.	AT
5450 AT	8½" W	8¼"	8"		4"	4" W, 7" H Back Plate			1-100w Med.	AT
4312 AT	½" Dia.	12" (stem)								AT

*Maximum achievable height with stems included. Additional stems available, see above.

PORTOFINO™

Finish Victorian Bronze
Glass Champagne marble
Details Hand-forged solid iron elements;
hand-wrapped vine detailing
See also Portofino bath, page 240



4119 VZ



4115 VZ



4113 VZ





4111 VZ



4114 VZ



5560 VZ



4117 VZ



4116 VZ



4118 VZ

PORTOFINO

Victorian Bronze (VZ)

ITEM	WIDTH/DIA.	HEIGHT	EXT.	DEPTH	TOP TO OUTLET	BACK PLATE/CANOPY	WIRE/CHAIN	STEMS INCLUDED	BULBS	AVAILABLE FINISHES
4111 VZ	18" Dia.	13¾"				5½" Dia. Canopy			3-75w Med.	VZ
4113 VZ	18" Dia.	20½"				5½" Dia. Canopy	6', 5'		3-100w Med.	VZ
4114 VZ	24½" Dia.	29"				5½" Dia. Canopy	6', 5'		3-75w Med.	VZ
4115 VZ	25" Dia.	26"				5½" Dia. Canopy	6', 5'		5-100w Med.	VZ
4116 VZ	24½" Dia.	29½"				5½" Dia. Canopy	6', 5'		6-100w Med.	VZ
4117 VZ	5" Dia.	6¾", 39¾" Max.*				5½" Dia. Canopy	10' Wire	1-6", 2-12"	1-100w Med.	VZ
4118 VZ	26¾" Dia.	33¾"				5½" Dia. Canopy	12', 10'		9-100w Med.	VZ
4119 VZ	37½" Dia.	44"				5½" Dia. Canopy	12', 10'		15-60w Med.	VZ
5560 VZ	5" W	12"	8"		7½"	5" W, 9" H Back Plate			1-100w Med.	VZ
4312 VZ	½" Dia.	12" (stem)								VZ

*Maximum achievable height with stems included. Additional stems available, see above.

PLYMOUTH™

- Finish Olde Bronze
Glass Mocha
Shades Light amber organza with decorative fabric trim
Details Finish features subtle hand rubbed highlights; vintage inspired candle sleeves and detailing
See also Plymouth bath, page 239



4249 OB 50





4243 OB



4246 OB



4247 OB



4248 OB



5470 OB



4240 OB

PLYMOUTH

Olde Bronze (OB)

ITEM	WIDTH/DIA.	HEIGHT	EXT.	DEPTH	TOP TO OUTLET	BACK PLATE/CANOPY	WIRE/CHAIN	STEMS INCLUDED	BULBS	AVAILABLE FINISHES
4240 OB	6½" W	14"	7½"		8½"	4½" W, 9¼" H Back Plate			1-60w Cand.	OB
4243 OB	18¼" Dia.	25¼"				5½" Dia. Canopy	6', 5'		3-60w Cand.	OB
4246 OB	27¾" Dia.	24¼"				5½" Dia. Canopy	6', 5'		6-60w Cand.	OB
4247 OB	6½" Dia.	10¾", 43" Max.*				5½" Dia. Canopy	10' Wire	1-6", 2-12"	1-100w Med.	OB
4248 OB	32¼" Dia.	31"				5½" Dia. Canopy	12', 10'		9-60w Cand.	OB
4249 OB	44½" Dia.	45"				5½" Dia. Canopy	12', 10'		15-40w Cand.	OB
5470 OB	5½" W	9½"	7¾"		4¾"	4½" W, 9¼" H Back Plate			1-100w Med.	OB
4312 OB	½" Dia.	12" (stem)								OB

*Maximum achievable height with stems included. Additional stems available, see above.



4241 OB



4242 OB



4252 OB



4245 OB



4244 OB

PLYMOUTH

Olde Bronze (OB)

ITEM	WIDTH/DIA.	HEIGHT	EXT.	DEPTH	TOP TO OUTLET	BACK PLATE/CANOPY	WIRE/CHAIN	STEMS INCLUDED	BULBS	AVAILABLE FINISHES
4241 OB	17½" Dia.	8¼"							3-60w Med.	OB
4242 OB	16" Dia.	12¼"				5½" Dia. Canopy			3-75w Med.	OB
4244 OB	24¾" Dia.	29¼"				5½" Dia. Canopy	12', 10'		3-75w Med.	OB
4245 OB	34" W	22½"		18½"		4½" W, 8" L Canopy	6', 5'		6-60w Cand.	OB
4252 OB	38½" W	23¼"		16"		4½" W, 8" L Canopy	6', 5'		2-100w Med.	OB



4258 OB



4259 OB 



4254 OB

PLYMOUTH

Olde Bronze (OB)

ITEM	WIDTH/DIA.	HEIGHT	EXT.	DEPTH	TOP TO OUTLET	BACK PLATE/CANOPY	WIRE/CHAIN	STEMS INCLUDED	BULBS	AVAILABLE FINISHES
4254 OB	17¾" Dia.	33½"				5½" Dia. Canopy	12', 10'		4-60w Cand.	OB
4258 OB	24" Dia.	43"				5½" Dia. Canopy	12', 10'		8-60w Cand.	OB
4259 OB	30" Dia.	55½"				5½" Dia. Canopy	12', 10'		9-60w Cand.	OB

DUNHILL™

Finish Royal Bronze
Shades Off-white pleated fabric
Glass Vintage faux alabaster
Details Faux wax candle sleeves



4599 RY





4591 RY



4595 RY



4590 RY



4598 RY



4594 RY

DUNHILL

Royal Bronze (RY)

ITEM	WIDTH/DIA.	HEIGHT	EXT.	DEPTH	TOP TO OUTLET	BACK PLATE/CANOPY	WIRE/CHAIN	STEMS INCLUDED	BULBS	AVAILABLE FINISHES
4590 RY	6¼" W	11¼"	8½"		5½"	6" Dia. Back Plate			1-60w Cand.	RY
4591 RY	16" Dia.	13"				6" Dia. Canopy			2-100w Med.	RY
4594 RY	20" Dia.	27½"				6" Dia. Canopy	12', 10'		3-100w Med.	RY
4595 RY	27¼" Dia.	26"				6" Dia. Canopy	6', 5'		5-60w Cand.	RY
4598 RY	37" Dia.	38¼"				6" Dia. Canopy	12', 10'		9-60w Cand.	RY
4599 RY	45" Dia.	42½"				6" Dia. Canopy	12', 10'		12-60w Cand.	RY

SLOAN™

Finish Regency Bronze
Shades Natural linen hard-back
Details Forged iron construction;
decorative etched lenses
(4541 RB, 4542 RB, 4543 RB
and 4547 RB only)



4543 RB



4541 RB



4546 RB



4548 RB





4545 RB



4540 RB



4542 RB



4547 RB



4544 RB

SLOAN

Regency Bronze (RB)

ITEM	WIDTH/DIA.	HEIGHT	EXT.	DEPTH	TOP TO OUTLET	BACK PLATE/CANOPY	WIRE/CHAIN	STEMS INCLUDED	BULBS	AVAILABLE FINISHES
4540 RB	4¾" W	16"	6¾"		8¼"	4¾" W, 12" H Back Plate			1-60w Cand.	RB
4541 RB	16" Dia.	10½"				5½" Dia. Canopy			2-75w Med.	RB
4542 RB	24" Dia.	23"				6" Dia. Canopy	12', 10'		3-100w Med.	RB
4543 RB	24" Dia.	14"				5½" Dia. Canopy			3-100w Med.	RB
4544 RB	50" W	25"		4¾"		4¾" W, 12" L Canopy	6', 5'		5-60w Cand.	RB
4545 RB	26" Dia.	25½"				6" Dia. Canopy	6', 5'		5-60w Cand.	RB
4546 RB	28" Dia.	28½"				6" Dia. Canopy	6', 5'		6-60w Cand.	RB
4547 RB	6" Dia.	15", 50" Max.*				6" Dia. Canopy	10' Wire	1-6", 2-12"	1-100w Med.	RB
4548 RB	36" Dia.	35½"				6" Dia. Canopy	12', 10'		9-60w Cand.	RB
4512 RB	¾" Dia.	12" (stem)								RB

*Maximum achievable height with stems included. Additional stems available, see above.

CORDILLERA™

- Finish Rustic Iron
Glass Light scavo
Details Fixtures are slightly oversized;
tall tubular closed glass;
three-quarter trim rings
See also Cordillera outdoor, pages 312-313



4099 RI





4094 RI



4098 RI



4090 RI

4097 RI



4096 RI



4095 RI

CORDILLERA

Rustic Iron (RI)

ITEM	WIDTH/DIA.	HEIGHT	EXT.	DEPTH	TOP TO OUTLET	BACK PLATE/CANOPY	WIRE/CHAIN	STEMS INCLUDED	BULBS	AVAILABLE FINISHES
4090 RI	7½" W	22"	6½"		13¼"	5½" W, 10" H Back Plate			1-60w Cand.	RI
4094 RI	19" Dia.	36"				7¼" Dia. Canopy	6', 5'		8-40w Cand.	RI
4095 RI	25" Dia.	25¼"				7¼" Dia. Canopy	6', 5'		10-40w Cand., 1-100w Med.	RI
4096 RI	34¼" W	24¼"		17"		16½" W, 4¾" L Canopy	6', 5'		12-40w Cand.	RI
4097 RI	7½" Dia.	22½", 55½" Max.*				7¼" Dia. Canopy	10' Wire	1-6", 2-12"	1-100w Med.	RI
4098 RI	23" Dia.	46"				7¼" Dia. Canopy	12', 10'		8-60w Cand.	RI
4099 RI	25½" Dia.	46"				7¼" Dia. Canopy	12', 10'		10-60w Cand.	RI
4312 RI	½" Dia.	12" (stem)								RI

*Maximum achievable height with stems included. Additional stems available, see above.

GOLD HILL™

Finish Olde Black
Glass Amber iridescent
Details Hand-forged scrollwork;
cast detailing



4058 OL



4059 OL 50



4053 OL





4052 OL ●



4051 OL



4055 OL ◐



4057 OL



4054 OL ●



5640 OL



4056 OL

GOLD HILL

Olde Black (OL)

ITEM	WIDTH/DIA.	HEIGHT	EXT.	DEPTH	TOP TO OUTLET	BACK PLATE/CANOPY	WIRE/CHAIN	STEMS INCLUDED	BULBS	AVAILABLE FINISHES
4051 OL	15½" Dia.	14¼"				4" Dia. Canopy			2-100w Med.	OL
4052 OL	20" Dia.	29½"				5½" Dia. Canopy	12', 10'		3-100w Med.	OL
4053 OL	26½" Dia.	25½"				5½" Dia. Canopy	6', 5'		3-100w Med.	OL
4054 OL	31" Dia.	38"				5½" Dia. Canopy	12', 10'		5-60w Med.	OL
4055 OL	36" W	22"		21"		6½" W, 8½" L Canopy	6', 5'		6-100w Med.	OL
4056 OL	29¾" Dia.	29½"				5½" Dia. Canopy	6', 5'		6-100w Med.	OL
4057 OL	5¼" Dia.	14½", 47" Max.*				5½" Dia. Canopy	10' Wire	1-6", 2-12"	1-100w Med.	OL
4058 OL	31¾" Dia.	32"				5½" Dia. Canopy	12', 10'		9-100w Med.	OL
4059 OL	42¼" Dia.	43¾"				5½" Dia. Canopy	12', 10'		16-60w Med.	OL
5640 OL	5¼" W	12½"	7½"		5½"	5" W, 7¾" H Back Plate			1-100w Med.	OL
4312 OL	½" Dia.	12" (stem)								OL

*Maximum achievable height with stems included. Additional stems available, see above.

CASA™

- Finish Olde Black
Glass Antique scavo
Details Individually unique glass; square shaped wrought iron features hand-forged twisted scrollwork
See also Casa bath, page 243
Casa outdoor, pages 314-315



4309 OL 





4011 OL



4013 OL



3501 OL



3508 OL



4019 OL 



4015 OL



4018 OL

CASA

Olde Black (OL)

ITEM	WIDTH/DIA.	HEIGHT	EXT.	DEPTH	TOP TO OUTLET	BACK PLATE/CANOPY	WIRE/CHAIN	STEMS INCLUDED	BULBS	AVAILABLE FINISHES
3501 OL	14¼" Dia.	8¾"							3-60w Med.	OL
3508 OL	36" W	24¼"		23"		5" W, 7" L Canopy	6', 5'		6-100w Med.	OL
4011 OL	13" Dia.	12"				5" Dia. Canopy			2-60w Med.	OL
4013 OL	16¾" Dia.	18½"				5" Dia. Canopy	6', 5'		3-100w Med.	OL
4015 OL	25" Dia.	25½"				5" Dia. Canopy	6', 5'		5-100w Med.	OL
4018 OL	28½" Dia.	32"				5" Dia. Canopy	12', 10'		9-100w Med.	OL
4019 OL	42" Dia.	45½"				6" Dia. Canopy	12', 10'		15-60w Med.	OL
4309 OL	56" Dia.	68"				6½" Dia. Canopy	12', 10'		18-60w Med.	OL



3504 OL



3506 OL



4010 OL



4300 OL 



3502 OL



4016 OL 



4308 OL

CASA

Olde Black (OL)

ITEM	WIDTH/DIA.	HEIGHT	EXT.	DEPTH	TOP TO OUTLET	BACK PLATE/CANOPY	WIRE/CHAIN	STEMS INCLUDED	BULBS	AVAILABLE FINISHES
3502 OL	14¼" Dia.	21"				5" Dia. Canopy	6', 5'		3-60w Cand.	OL
3504 OL	17¾" Dia.	29½"				5" Dia. Canopy	6', 5'		3-100w Med.	OL
3506 OL	22½" Dia.	41"				5" Dia. Canopy	12', 10'		6-100w Med.	OL
4010 OL	5" W	10¾"	6"		6¾"	5" W, 7¾" H Back Plate			1-100w Med.	OL
4016 OL	38" W	24½"		24"		5" W, 7" L Canopy	6', 5'		8-75w Med.	OL
4300 OL	5" W	24"	4"		11"	5" W, 7¾" H Back Plate			1-100w Med.	OL
4308 OL	36½" W	30"				6½" Dia. Canopy	12', 10'		8-100w Med.	OL



4314 OL ●



4311 OL



4316 OL ●



3503 OL



4017 OL

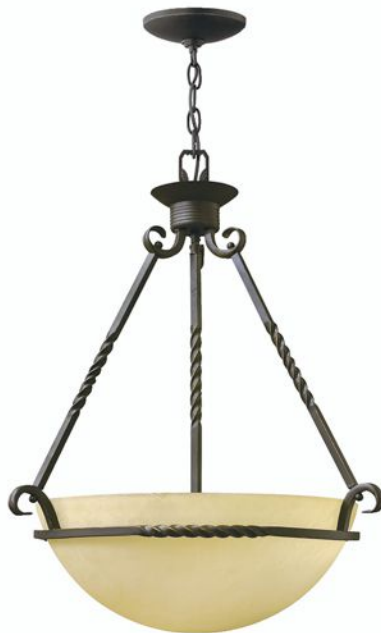

4313 OL ●



4304 OL

CASA

Olde Black (OL)

ITEM	WIDTH/DIA.	HEIGHT	EXT.	DEPTH	TOP TO OUTLET	BACK PLATE/CANOPY	WIRE/CHAIN	STEMS INCLUDED	BULBS	AVAILABLE FINISHES
3503 OL	12½" Dia.	17½"				5" Dia. Canopy	12', 10'		3-60w Cand.	OL
4304 OL	54" W	28½"		5"		5" W, 7" L Canopy	6', 5'		6-100w Med.	OL
4017 OL	5½" Dia.	13", 45" Max.*				5" Dia. Canopy	10' Wire	1-6", 2-12"	1-100w Med.	OL
4311 OL	23" Dia.	14"				5¾" Dia. Canopy			3-100w Med.	
4313 OL	22½" Dia.	26½"				6¼" Dia. Canopy	6', 5'		3-75w Med.	OL
4314 OL	27¼" Dia.	32"				6¼" Dia. Canopy	6', 5'		4-75w Med.	OL
4316 OL	38½" Dia.	41¾"				6¼" Dia. Canopy	6', 5'		6-75w Med.	OL
4312 OL	½" Dia.	12" (stem)								OL

*Maximum achievable height with stems included. Additional stems available, see above.

VERANDA™

- Finish Summerstone
- Glass Hand-detailed veneto
- Shades Hand-sewn silk
- Details Wrought-iron construction;
finish features crackled bronze detailing;
clear crystal teardrop pendalogues



4899 SU 





4808 SU



4807 SU 



4891 SU



4802 SU



4892 SU



4809 SU 

VERANDA

Summerstone (SU)

ITEM	WIDTH/DIA.	HEIGHT	EXT.	DEPTH	TOP TO OUTLET	BACK PLATE/CANOPY	WIRE/CHAIN	STEMS INCLUDED	BULBS	AVAILABLE FINISHES
4802 SU	14½" W	17¾"	8"		13¾"	4½" W, 8" H Back Plate			2-60w Cand.	SU
4807 SU	46¾" Dia.	57"				8" Dia. Canopy	12', 10'		15-40w Cand.	SU
4808 SU	20" Dia.	27¼"				6" Dia. Canopy	6', 5'		3-60w Cand.	SU
4809 SU	34¼" Dia.	46¾"				6" Dia. Canopy	12', 10'		9-60w Cand.	SU
4891 SU	16" Dia.	8"							3-60w Med.	SU
4892 SU	25" Dia.	19¾"				6" Dia. Canopy	6', 5'		3-60w Med.	SU
4899 SU	56" Dia.	70"				8" Dia. Canopy	12', 10'		16-40w Cand.	SU



4806 SU



4801 SU



4800 SU 
(pocket sconce)



4803 SU



4896 SU 



4805 SU

VERANDA

Summerstone (SU)

ITEM	WIDTH/DIA.	HEIGHT	EXT.	DEPTH	TOP TO OUTLET	BACK PLATE/CANOPY	WIRE/CHAIN	STEMS INCLUDED	BULBS	AVAILABLE FINISHES
4800 SU	13" W	12¼"	4"		5¼"	6½" W, 6½" H Back Plate			1-60w Cand.	SU
4801 SU	20" Dia.	16"				6" Dia. Canopy			2-60w Med.	SU
4803 SU	18" Dia.	35"				6" Dia. Canopy	6', 5'		2-40w Cand.	SU
4805 SU	31" Dia.	39"				6" Dia. Canopy	6', 5'		5-60w Cand.	SU
4806 SU	26" Dia.	29"				6" Dia. Canopy	6', 5'		5-60w Cand.	SU
4896 SU	38" W	31¼"		23"		5½" W, 12" L Canopy	6', 5'		6-60w Cand.	SU



3723 SU



3724 SU



4897 SU



3729 SU



4893 SU

VERANDA

Summerstone (SU)

ITEM	WIDTH/DIA.	HEIGHT	EXT.	DEPTH	TOP TO OUTLET	BACK PLATE/CANOPY	WIRE/CHAIN	STEMS INCLUDED	BULBS	AVAILABLE FINISHES
3723 SU	17" Dia.	13¼"							3-60w Cand.	SU
3724 SU	18¼" Dia.	29"				7" Dia. Canopy	12', 10'		4-60w Cand.	SU
3729 SU	43¼" Dia.	64"				7" Dia. Canopy	12', 10'		12-60w Cand.	SU
4893 SU	12½" Dia.	15½"				6" Dia. Canopy	12', 10'		3-60w Cand.	SU
4897 SU	8¾" Dia.	11¼", 45" Max.*				6" Dia. Canopy	10' Wire	1-6", 2-12"	1-100w Med.	SU
4312 SU	½" Dia.	12" (stem)								SU

*Maximum achievable height with stems included. Additional stems available, see above.

MARCELLINA™

- Finish Golden Bronze
Shades Patterned silk (optional)
Details Cast leaf detailing features
silver highlights; crystal bobesches,
crystal ball finial and large solid
crystal center gazing ball



4408 GR





4401 OW
(optional shade)



4405 GR



4400 GR



4403 GR



4406 GR
(shown with optional shade)



4404 GR

MARCELLINA

Golden Bronze (GR)

ITEM	WIDTH/DIA.	HEIGHT	EXT.	DEPTH	TOP TO OUTLET	BACK PLATE/CANOPY	WIRE/CHAIN	BULBS	AVAILABLE FINISHES
4400 GR*	6½" W	19"	6½"		7"	6½" W, 11¼" H Back Plate		1-60w Cand.	GR
4403 GR	15" Dia.	19¾"				6¼" Dia. Canopy	12', 10'	3-60w Cand.	GR
4404 GR*	39" Dia.	42"				6¼" Dia. Canopy	12', 10'	8-60w Cand.	GR
4405 GR	25" Dia.	28"				6¼" Dia. Canopy	12', 10'	5-60w Cand.	GR
4406 GR*	28½" Dia.	36"				6¼" Dia. Canopy	12', 10'	6-60w Cand.	GR
4408 GR*	47" Dia.	53"				6¼" Dia. Canopy	12', 10'	15-60w Cand.	GR
4401 OW	3½" Dia. Top, 5¾" Dia. Bottom	6½"						Do not exceed 40w	OW

*Shade(s) optional with select Marcellina fixtures.

CARLTON™

Finish Silver Leaf
Details Ornate leaf detailing; finish features soft gold accents; delicate spun bobesches; amber pearl crystals



4778 SL





4775 SL



4772 SL



4776 SL

CARLTON

Silver Leaf (SL)

ITEM	WIDTH/DIA.	HEIGHT	EXT.	DEPTH	TOP TO OUTLET	BACK PLATE/CANOPY	WIRE/CHAIN	STEMS INCLUDED	BULBS	AVAILABLE FINISHES
4772 SL	13½" W	19"	7"		9"	5" Dia. Back Plate			2-60w Cand.	SL
4775 SL	24" Dia.	25"				7" Dia. Canopy	6', 5'		5-60w Cand.	SL
4776 SL	28" Dia.	28½"				7" Dia. Canopy	6', 5'		6-60w Cand.	SL
4778 SL	35" Dia.	36"				7" Dia. Canopy	10', 12'		12-60w Cand.	SL

PLANTATION™

- Finish Burnished Brass
Glass Clear optic
Shades Ivory silk
Details Pineapple shaped center glass is individually switched; Burnished Brass candle sleeves; decorative cast detailing
See also Plantation bath, pages 249-250
Plantation outdoor, pages 382-387



4889 BB 





4886 BB



4883 BB



4880 BB



4887 BB 

PLANTATION

Burnished Brass (BB)

ITEM	WIDTH/DIA.	HEIGHT	EXT.	DEPTH	TOP TO OUTLET	BACK PLATE/CANOPY	WIRE/CHAIN	STEMS INCLUDED	BULBS	AVAILABLE FINISHES
4880 BB	6" W	15"	8¾"		10¾"	6" Dia. Back Plate			1-60w Cand.	BB, PL, PZ
4883 BB	21½" Dia.	29½"				6" Dia. Canopy	6', 5'		4-60w Cand.*	BB, PL, PZ
4886 BB	28" Dia.	33"				6" Dia. Canopy	6', 5'		7-60w Cand.*	BB, PL, PZ
4887 BB	33" Dia.	36¾"				6" Dia. Canopy	12', 10'		10-60w Cand.*	BB, PZ
4889 BB	56" Dia.	54"				6" Dia. Canopy	12', 10'		21-25w Cand., 1-25w Med.*	BB, PZ

*Lighted center font, switched.



4103 BB



2222 BB 



4140 BB



5310 BB



4882 BB  

PLANTATION

Burnished Brass (BB)

ITEM	WIDTH/DIA.	HEIGHT	EXT.	DEPTH	TOP TO OUTLET	BACK PLATE/CANOPY	WIRE/CHAIN	STEMS INCLUDED	BULBS	AVAILABLE FINISHES
2222 BB	12½" Dia.	28½"				6" Dia. Canopy	6', 5'		4-40w Cand.	BB, CB, PL, PZ
4103 BB	13" Dia.	19"				6" Dia. Canopy	12', 10'		3-60w Cand.	BB, PL, PZ
4140 BB	6" W	14½"	8½"	8½"		4¾" W, 12" H Back Plate			1-60w Cand.	BB, PZ
4882 BB	18" Dia.	40"				6" Dia. Canopy	12', 10'		6-40w Cand.	BB, CB, PZ
5310 BB	5" W	8¾"	7"		5"	5" W, 8" H Back Plate			1-75w Med.	BB, PL, PZ



4881 BB



4102 BB



4143 BB



4885 BB



5317 BB

PLANTATION

Burnished Brass (BB)

ITEM	WIDTH/DIA.	HEIGHT	EXT.	DEPTH	TOP TO OUTLET	BACK PLATE/CANOPY	WIRE/CHAIN	STEMS INCLUDED	BULBS	AVAILABLE FINISHES
4102 BB	12" Dia.	8"							2-60w Med.	BB, CB, PL, PZ
4143 BB	15" Dia.	11½", 15½"				6" Dia. Canopy	6', 5'		3-75w Med.	BB, PZ
4881 BB	16" Dia.	8¾"							3-60w Med.	BB, CB, PL, PZ
4885 BB	22" Dia.	24½"				6" Dia. Canopy	6', 5'		5-75w Med.	BB, PL, PZ
5317 BB	5" Dia.	8¼", 40¾" Max.**				6" Dia. Canopy	10' Wire	1-6", 2-12"	1-100w Med.	BB, PL, PZ
4312 BB	½" Dia.	12" (stem)								BB, PL, PZ

*Height when hung with chain (includes loop). **Maximum achievable height with stems included. Additional stems available, see above.

PLANTATION™

- Finish Pearl Bronze
Glass Clear optic
Shades Ivory silk
Details Pineapple shaped center glass is individually switched; off-white candle sleeves; decorative cast detailing
See also Plantation bath, pages 249-250
Plantation outdoor, pages 382-387



4889 PZ





4886 PZ



4883 PZ



4880 PZ



4887 PZ 

PLANTATION

Pearl Bronze (PZ)

ITEM	WIDTH/DIA.	HEIGHT	EXT.	DEPTH	TOP TO OUTLET	BACK PLATE/CANOPY	WIRE/CHAIN	STEMS INCLUDED	BULBS	AVAILABLE FINISHES
4880 PZ	6" W	15"	8¾"		10¾"	6" Dia. Back Plate			1-60w Cand.	BB, PL, PZ
4883 PZ	21½" Dia.	29½"				6" Dia. Canopy	6', 5'		4-60w Cand.*	BB, PL, PZ
4886 PZ	28" Dia.	33"				6" Dia. Canopy	6', 5'		7-60w Cand.*	BB, PL, PZ
4887 PZ	33" Dia.	36¾"				6" Dia. Canopy	12', 10'		10-60w Cand.*	BB, PZ
4889 PZ	56" Dia.	54"				6" Dia. Canopy	12', 10'		21-25w Cand., 1-25w Med.*	BB, PZ

*Lighted center font, switched.



4103 PZ



2222 PZ 



4140 PZ



5310 PZ



4882 PZ  

PLANTATION

Pearl Bronze (PZ)

ITEM	WIDTH/DIA.	HEIGHT	EXT.	DEPTH	TOP TO OUTLET	BACK PLATE/CANOPY	WIRE/CHAIN	STEMS INCLUDED	BULBS	AVAILABLE FINISHES
2222 PZ	12½" Dia.	28½"				6" Dia. Canopy	6', 5'		4-40w Cand.	BB, CB, PL, PZ
4103 PZ	13" Dia.	19"				6" Dia. Canopy	12', 10'		3-60w Cand.	BB, PL, PZ
4140 PZ	6" W	14½"	8½"	8½"		4¾" W, 12" H Back Plate			1-60w Cand.	BB, PZ
4882 PZ	18" Dia.	40"				6" Dia. Canopy	12', 10'		6-40w Cand.	BB, CB, PZ
5310 PZ	5" W	8¾"	7"	5"		5" W, 8" H Back Plate			1-75w Med.	BB, PL, PZ



4881 PZ 



4102 PZ 



4143 PZ 



4885 PZ



5317 PZ

PLANTATION

Pearl Bronze (PZ)

ITEM	WIDTH/DIA.	HEIGHT	EXT.	DEPTH	TOP TO OUTLET	BACK PLATE/CANOPY	WIRE/CHAIN	STEMS INCLUDED	BULBS	AVAILABLE FINISHES
4102 PZ	12" Dia.	8"							2-60w Med.	BB, CB, PL, PZ
4143 PZ	15" Dia.	11½", 15½"				6" Dia. Canopy	6', 5'		3-75w Med.	BB, PZ
4881 PZ	16" Dia.	8¾"							3-60w Med.	BB, CB, PL, PZ
4885 PZ	22" Dia.	24½"				6" Dia. Canopy	6', 5'		5-75w Med.	BB, PL, PZ
5317 PZ	5" Dia.	8¼", 40¾" Max.**				6" Dia. Canopy	10' Wire	1-6", 2-12"	1-100w Med.	BB, PL, PZ
4312 PZ	½" Dia.	12" (stem)								BB, PL, PZ

*Height when hung with chain (includes loop). **Maximum achievable height with stems included. Additional stems available, see above.

PLANTATION™

- Finish Polished Antique Nickel
- Glass Clear optic
- Shades Ivory silk
- Details Pineapple shaped center glass is individually switched; Polished Antique Nickel candle sleeves; decorative cast detailing
- See also Plantation bath, pages 249-250
Plantation outdoor, pages 382-387



4886 PL



5317 PL



4883 PL



4880 PL





4885 PL



4881 PL



4102 PL



5310 PL



2222 PL



4103 PL

PLANTATION

Polished Antique Nickel (PL)

ITEM	WIDTH/DIA.	HEIGHT	EXT.	DEPTH	TOP TO OUTLET	BACK PLATE/CANOPY	WIRE/CHAIN	STEMS INCLUDED	BULBS	AVAILABLE FINISHES
2222 PL	12½" Dia.	28½"				6" Dia. Canopy	6', 5'		4-40w Cand.	BB, CB, PL, PZ
4102 PL	12" Dia.	8"							2-60w Med.	BB, CB, PL, PZ
4103 PL	13" Dia.	19"				6" Dia. Canopy	12', 10'		3-60w Cand.	BB, PL, PZ
4880 PL	6" W	15"	8¾"		10¾"	6" Dia. Back Plate			1-60w Cand.	BB, PL, PZ
4881 PL	16" Dia.	8¾"							3-60w Med.	BB, CB, PL, PZ
4883 PL	21½" Dia.	29½"				6" Dia. Canopy	6', 5'		4-60w Cand.**	BB, PL, PZ
4885 PL	22" Dia.	24½"				6" Dia. Canopy	6', 5'		5-75w Med.	BB, PL, PZ
4886 PL	28" Dia.	33"				6" Dia. Canopy	6', 5'		7-60w Cand.**	BB, PL, PZ
5310 PL	5" W	8¾"	7"		5"	5" W, 8" H Back Plate			1-75w Med.	BB, PL, PZ
5317 PL	5" Dia.	8¾", 40¾" Max.*				6" Dia. Canopy	10' Wire	1-6", 2-12"	1-100w Med.	BB, PL, PZ
4312 PL	½" Dia.	12" (stem)								BB, PL, PZ

*Maximum achievable height with stems included. Additional stems available, see above. **Lighted center font, switched.

CAMBRIDGE™

Finish Burnished Brass
Glass Clear optic
Shades Pleated off-white fabric (optional)
 Ivory hard-back linen (3610 BB only)
Details Solid cast components and
 brass turnings; beaded ball fonts;
 off-white candle sleeves with
 Burnished Brass candle chasers



4415 BB



4419 BB 



4423 BB 

CAMBRIDGE

Burnished Brass (BB)

ITEM	WIDTH/DIA.	HEIGHT	EXT.	DEPTH	TOP TO OUTLET	BACK PLATE/CANOPY	WIRE/CHAIN	STEMS INCLUDED	BULBS	AVAILABLE FINISHES
4415 BB	25", 26" Dia.*	26¼"				6¼" Dia. Canopy	6', 5'		5-60w Cand.	BB, OB, PW
4419 BB	48½", 49½" Dia.*	46"				6¼" Dia. Canopy	12', 10'		25-25w Cand.	BB, OB, PW
4423 BB	13½", 14½" Dia.*	14", 15½"***				6¼" Dia. Canopy	6', 5'		3-60w Cand.	BB, OB, PW

*Measurement with shades (includes loop). **Height when hung with chain.



4410 BB



4412 BB
(shown with optional shade)



3610 BB 
(shade included)



4421 OW
(optional shade)



4417 BB 



4416 BB

CAMBRIDGE

Burnished Brass (BB)

ITEM	WIDTH/DIA.	HEIGHT	EXT.	DEPTH	TOP TO OUTLET	BACK PLATE/CANOPY	WIRE/CHAIN	BULBS	AVAILABLE FINISHES
3610 BB	14½" W	18"	4"		14"	4¾" W, 7¾" H Back Plate		2-60w Cand.	BB, OB, PW
4410 BB	4½", 5½" W*	11"	9½"		9¼"	4½" W, 6½" H Back Plate		1-60w Cand.	BB, OB, PW
4412 BB	15", 16" W*	11"	7"		9¼"	4½" W, 6½" H Back Plate		2-60w Cand.	BB, OB, PW
4416 BB	28½", 29½" Dia.*	26½"				6¼" Dia. Canopy	6', 5'	6-60w Cand.	BB, OB, PW
4417 BB	35½", 36½" Dia.*	34½"				6¼" Dia. Canopy	12', 10'	15-40w Cand.	BB, OB, PW
4421 OW	3½" Dia. Top, 5½" Dia. Bottom	5"						Do not exceed 40w	OW

*Measurement with shades.



3614 BB



3616 BB



3612 BB



3613 BB



3615 BB



4642 BB



4640 BB

CAMBRIDGE

Burnished Brass (BB)

ITEM	WIDTH/DIA.	HEIGHT	EXT.	DEPTH	TOP TO OUTLET	BACK PLATE/CANOPY	WIRE/CHAIN	STEMS INCLUDED	BULBS	AVAILABLE FINISHES
3612 BB	14½" Dia.	13"							3-60w Cand.	BB, OB, PW
3613 BB	21¼" Dia.	21", 22½"				6¾" Dia. Canopy	12', 10'		3-60w Cand.	BB, OB, PW
3614 BB	22½" Dia.	44½"				6¾" Dia. Canopy	12', 10'		3-60w Cand.	BB, OB, PW
3615 BB	30½" Dia.	63½"				6¾" Dia. Canopy	12', 10'		10-60w Cand.	BB, OB, PW
3616 BB	16¼" Dia.	7½"							2-60w Med.	BB, OB, PW
4640 BB	4½" W	13"	9½"	9½"	9½"	4½" W, 6½" H Back Plate			1-60w Cand.	BB
4642 BB	14" W	13½"	8"	9"	9"	4½" W, 6½" H Back Plate			2-60w Cand.	BB

*Height when hung with chain (includes loop).

CAMBRIDGE™

Finish Pewter
Glass Clear optic
Shades Pleated off-white fabric (optional)
 Ivory hard-back linen (3610 PW only)
Details Solid cast components and
 brass turnings; beaded ball fonts;
 white candle sleeves with
 Pewter candle chasers



4415 PW



4423 PW



4419 PW

CAMBRIDGE

Pewter (PW)

ITEM	WIDTH/DIA.	HEIGHT	EXT.	DEPTH	TOP TO OUTLET	BACK PLATE/CANOPY	WIRE/CHAIN	STEMS INCLUDED	BULBS	AVAILABLE FINISHES
4415 PW	25", 26" Dia.*	26¼"				6¼" Dia. Canopy	6', 5'		5-60w Cand.	BB, OB, PW
4419 PW	48½", 49½" Dia.*	46"				6¼" Dia. Canopy	12', 10'		25-25w Cand.	BB, OB, PW
4423 PW	13½", 14½" Dia.*	14", 15½***				6¼" Dia. Canopy	6', 5'		3-60w Cand.	BB, OB, PW

*Measurement with shades. **Height when hung with chain (includes loop).



4410 PW



4412 PW
(shown with optional shade)



3610 PW 
(shade included)



5122 BK
(optional shade)



4417 PW 



4416 PW

CAMBRIDGE

Pewter (PW)

ITEM	WIDTH/DIA.	HEIGHT	EXT.	DEPTH	TOP TO OUTLET	BACK PLATE/CANOPY	WIRE/CHAIN	BULBS	AVAILABLE FINISHES
3610 PW	14½" W	18"	4"		14"	4¾" W, 7¾" H Back Plate		2-60w Cand.	BB, OB, PW
4410 PW	4½", 5½" W*	11"	9½"		9¼"	4½" W, 6½" H Back Plate		1-60w Cand.	BB, OB, PW
4412 PW	15", 16" W*	11"	7"		9¼"	4½" W, 6½" H Back Plate		2-60w Cand.	BB, OB, PW
4416 PW	28½", 29½" Dia.*	26½"				6¼" Dia. Canopy	6', 5'	6-60w Cand.	BB, OB, PW
4417 PW	35½", 36½" Dia.*	34½"				6¼" Dia. Canopy	12', 10'	15-40w Cand.	BB, OB, PW
5122 BK	3½" Dia. Top, 5½" Dia. Bottom	5"						Do not exceed 40w	BK

*Measurement with shades.



3612 PW



3616 PW



3613 PW 



3615 PW 



3614 PW

CAMBRIDGE

Pewter (PW)

ITEM	WIDTH/DIA.	HEIGHT	EXT.	DEPTH	TOP TO OUTLET	BACK PLATE/CANOPY	WIRE/CHAIN	STEMS INCLUDED	BULBS	AVAILABLE FINISHES
3612 PW	14½" Dia.	13"							3-60w Cand.	BB, OB, PW
3613 PW	21¼" Dia.	21", 22½"				6¾" Dia. Canopy	12', 10'		3-60w Cand.	BB, OB, PW
3614 PW	22½" Dia.	44½"				6¾" Dia. Canopy	12', 10'		3-60w Cand.	BB, OB, PW
3615 PW	30½" Dia.	63½"				6¾" Dia. Canopy	12', 10'		10-60w Cand.	BB, OB, PW
3616 PW	16¼" Dia.	7½"							2-60w Med.	BB, OB, PW

*Height when hung with chain (includes loop).

CAMBRIDGE™

- Finish Olde Bronze
- Glass Clear optic
- Shades Pleated off-white fabric (optional)
Ivory hard-back linen (3610 OB only)
- Details Solid cast components and
brass turnings; beaded ball fonts;
off-white candle sleeves with
Olde Bronze candle chasers



CAMBRIDGE

Olde Bronze (OB)

ITEM	WIDTH/DIA.	HEIGHT	EXT.	DEPTH	TOP TO OUTLET	BACK PLATE/CANOPY	WIRE/CHAIN	STEMS INCLUDED	BULBS	AVAILABLE FINISHES
4415 OB	25", 26" Dia.*	26¼"				6¼" Dia. Canopy	6', 5'		5-60w Cand.	BB, OB, PW
4419 OB	48½", 49½" Dia.*	46"				6¼" Dia. Canopy	12', 10'		25-25w Cand.	BB, OB, PW
4423 OB	13½", 14½" Dia.*	14", 15½"***				6¼" Dia. Canopy	6', 5'		3-60w Cand.	BB, OB, PW

*Measurement with shades. **Height when hung with chain (includes loop).



4410 OB



4412 OB
(shown with optional shade)



3610 OB 
(shade included)



4421 OW
(optional shade)



4417 OB 



4416 OB

CAMBRIDGE

Olde Bronze (OB)

ITEM	WIDTH/DIA.	HEIGHT	EXT.	DEPTH	TOP TO OUTLET	BACK PLATE/CANOPY	WIRE/CHAIN	BULBS	AVAILABLE FINISHES
3610 OB	14½" W	18"	4"		14"	4¾" W, 7¾" H Back Plate		2-60w Cand.	BB, OB, PW
4410 OB	4½", 5½" W*	11"	9½"		9¼"	4½" W, 6½" H Back Plate		1-60w Cand.	BB, OB, PW
4412 OB	15", 16" W*	11"	7"		9¼"	4½" W, 6½" H Back Plate		2-60w Cand.	BB, OB, PW
4416 OB	28½", 29½" Dia.*	26½"				6¼" Dia. Canopy	6', 5'	6-60w Cand.	BB, OB, PW
4417 OB	35½", 36½" Dia.*	34½"				6¼" Dia. Canopy	12', 10'	15-40w Cand.	BB, OB, PW
4421 OW	3½" Dia. Top, 5½" Dia. Bottom	5"						Do not exceed 40w	OW

*Measurement with shades.



3612 OB



3616 OB



3613 OB



3615 OB



3614 OB

CAMBRIDGE

Olde Bronze (OB)

ITEM	WIDTH/DIA.	HEIGHT	EXT.	DEPTH	TOP TO OUTLET	BACK PLATE/CANOPY	WIRE/CHAIN	STEMS INCLUDED	BULBS	AVAILABLE FINISHES
3612 OB	14½" Dia.	13"							3-60w Cand.	BB, OB, PW
3613 OB	21¼" Dia.	21", 22½"				6¾" Dia. Canopy	12', 10'		3-60w Cand.	BB, OB, PW
3614 OB	22½" Dia.	44½"				6¾" Dia. Canopy	12', 10'		3-60w Cand.	BB, OB, PW
3615 OB	30½" Dia.	63½"				6¾" Dia. Canopy	12', 10'		10-60w Cand.	BB, OB, PW
3616 OB	16¼" Dia.	7½"							2-60w Med.	BB, OB, PW

*Height when hung with chain (includes loop).



Fixture shown: Cambridge 4415 PW, page 151

ROCKFORD™

Finish Forum Bronze
Glass Clear seedy hurricane
Details Off-white candle sleeves with Forum Bronze candle chasers; cast urn centerpiece and beaded two-tier bobesches



4626 FB





ROCKFORD		Forum Bronze (FB)								
ITEM	WIDTH/DIA.	HEIGHT	EXT.	DEPTH	TOP TO OUTLET	BACK PLATE/CANOPY	WIRE/CHAIN	STEMS INCLUDED	BULBS	AVAILABLE FINISHES
3712 FB	14½" Dia.	12¼"							3-60w Cand.	FB
3713 FB	20¾" Dia.	21", 24½"				6¾" Dia. Canopy	6', 5'		3-60w Cand.	FB
3714 FB	23" Dia.	42½"				6¾" Dia. Canopy	12', 10'		3-60w Cand.	FB
3716 FB	16¼" Dia.	7½"							2-60w Med.	FB
4620 FB	5" W	13"	9½"		8½"	4½" W, 6½" H Back Plate			1-60w Cand.	FB
4622 FB	14" W	13½"	7½"		9"	4½" W, 6½" H Back Plate			2-60w Cand.	FB
4623 FB	15¼" Dia.	17¼", 19¼"				6¾" Dia. Canopy	6', 5'		3-60w Cand.	FB
4626 FB	26¾" Dia.	29¼"				6¾" Dia. Canopy	6', 5'		6-60w Cand.	FB

*Height when hung with chain (includes loop).

VIRGINIAN™

- Finish Pewter
Shade Black parchment with gold metallic lining (optional)
Details Cast center column and detailing; spun ball accents; white candle sleeves



5127 PW 





5122 BK
(optional shade)



5124 PW



5120 PW



5129 PW



5126 PW
(shown with optional shade)



5128 PW

VIRGINIAN

Pewter (PW)

ITEM	WIDTH/DIA.	HEIGHT	EXT.	DEPTH	TOP TO OUTLET	BACK PLATE/CANOPY	WIRE/CHAIN	BULBS	AVAILABLE FINISHES
5120 PW	4¼", 5½" W*	11"	7"		6"	4¼" W, 6" H Back Plate		1-60w Cand.**	PB, PW
5124 PW	11", 13" W*	11"	4½"		7"	4¼" W, 6" H Back Plate		2-60w Cand.**	PB, PW
5126 PW	22", 25" Dia.*	22"				5½" Dia. Canopy	6', 5'	6-60w Cand.	PB, PW
5127 PW	37", 40" Dia.*	44"				5½" Dia. Canopy	12', 10'	20-25w Cand.	PB, PW
5128 PW	30", 33" Dia.*	25"				5½" Dia. Canopy	6', 5'	8-60w Cand.	PB, PW
5129 PW	30", 33" Dia.*	34½"				5½" Dia. Canopy	12', 10'	12-60w Cand.	PB, PW
5122 BK	3½" Dia. Top, 5½" Dia. Bottom	5"						Do not exceed 40w	BK

*Measurement with shades. **Switched.

VIRGINIAN™

- Finish Polished Brass
Shade Black parchment with gold metallic lining (optional)
Details Cast center column and detailing; spun ball accents; white candle sleeves



5127 PB 





5122 BK
(optional shade)



5124 PB
(shown with optional shade)



5120 PB



5129 PB



5126 PB



5128 PB

VIRGINIAN

Polished Brass (PB)

ITEM	WIDTH/DIA.	HEIGHT	EXT.	DEPTH	TOP TO OUTLET	BACK PLATE/CANOPY	WIRE/CHAIN	BULBS	AVAILABLE FINISHES
5120 PB	4¼", 5½" W*	11"	7"		6"	4¼" W, 6" H Back Plate		1-60w Cand.**	PB, PW
5124 PB	11", 13" W*	11"	4½"		7"	4¼" W, 6" H Back Plate		2-60w Cand.**	PB, PW
5126 PB	22", 25" Dia.*	22"				5½" Dia. Canopy	6', 5'	6-60w Cand.	PB, PW
5127 PB	37", 40" Dia.*	44"				5½" Dia. Canopy	12', 10'	20-25w Cand.	PB, PW
5128 PB	30", 33" Dia.*	25"				5½" Dia. Canopy	6', 5'	8-60w Cand.	PB, PW
5129 PB	30", 33" Dia.*	34½"				5½" Dia. Canopy	12', 10'	12-60w Cand.	PB, PW
5122 BK	3½" Dia. Top, 5½" Dia. Bottom	5"						Do not exceed 40w	BK

*Measurement with shades. **Switched.

GENTRY™

Finish Polished Brass
Glass Clear rounded panels
Details Solid brass construction;
white candle sleeves with
Polished Brass candle chasers



3479 PB





3472 PB



3473 PB



3478 PB



3470 PB



3474 PB

GENTRY

Polished Brass (PB)

ITEM	WIDTH/DIA.	HEIGHT	EXT.	DEPTH	TOP TO OUTLET	BACK PLATE/CANOPY	WIRE/CHAIN	STEMS INCLUDED	BULBS	AVAILABLE FINISHES
3470 PB	8" Dia.	12"				5½" Dia. Canopy	6', 5'		3-60w Cand.	PB, PW
3472 PB	9½" Dia.	9¼"							2-40w Cand.	PB, PW
3473 PB	11½" Dia.	9½"							3-40w Cand.	PB, PW
3474 PB	12" Dia.	20"				5½" Dia. Canopy	6', 5'		4-60w Cand.	PB, PW
3478 PB	14" Dia.	25"				5½" Dia. Canopy	12', 10'		6-60w Cand.	PB, PW
3479 PB	17" Dia.	41"				5½" Dia. Canopy	12', 10'		12-60w Cand.	PB, PW

GENTRY™

Finish Pewter
Glass Clear rounded panels
Details Solid brass construction;
white candle sleeves with
Pewter candle chasers



3479 PW





3472 PW



3473 PW



3478 PW



3470 PW



3474 PW

GENTRY		Pewter (PW)								
ITEM	WIDTH/DIA.	HEIGHT	EXT.	DEPTH	TOP TO OUTLET	BACK PLATE/CANOPY	WIRE/CHAIN	STEMS INCLUDED	BULBS	AVAILABLE FINISHES
3470 PW	8" Dia.	12"				5½" Dia. Canopy	6', 5'		3-60w Cand.	PB, PW
3472 PW	9½" Dia.	9¼"							2-40w Cand.	PB, PW
3473 PW	11½" Dia.	9½"							3-40w Cand.	PB, PW
3474 PW	12" Dia.	20"				5½" Dia. Canopy	6', 5'		4-60w Cand.	PB, PW
3478 PW	14" Dia.	25"				5½" Dia. Canopy	12', 10'		6-60w Cand.	PB, PW
3479 PW	17" Dia.	41"				5½" Dia. Canopy	12', 10'		12-60w Cand.	PB, PW



FREDRICK RAMOND

ESTABLISHED 1965

LUXURY LIGHTING

R E D E F I N E D

EXPERIENCE FREDRICK RAMOND

OUR UNIQUE COLLECTIONS ARE CONCEIVED WITH A FOCUS ON ARTISAN CRAFTSMANSHIP, QUALITY AND DESIGNS THAT ARE AS TRUE TO FORM AS THEY ARE FUNCTION. EACH PIECE IS MADE TO BE TREASURED AND CELEBRATES A CULTURED SENSE OF STYLE AND DISCRIMINATING TASTE. HAND-APPLIED FINISHES AND CUSTOM DETAILS ACCENTUATE THE DISTINCTIVE APPEAL OF EACH FREDRICK RAMOND COLLECTION.

RR



Mondo™

This sleek contemporary cable-hung collection features seven styles in a brilliant Polished Chrome finish complemented by cube-shaped frosted glass.



CHANDELIERS

THESE FEATURED COLLECTIONS BRILLIANTLY
REFLECT THE FREDRICK RAMOND LEGACY

FREDRICK RAMOND FEATURES STYLISH CHANDELIER COLLECTIONS THAT OFFER CHIC DESIGNS COUPLED WITH SUPERIOR QUALITY TO INDULGE EVEN THE MOST EXTRAVAGANT TASTES. SUBTLE YET LUXURIOUS NUANCES, FROM RICH, HAND-APPLIED FINISHES TO SHIMMERING CRYSTAL DETAILS, HONOR THE FREDRICK RAMOND HERITAGE AND ADD A LAYER OF RICHNESS AND SOPHISTICATED TO EVERY ROOM. EXPERIENCE FREDRICK RAMOND CHANDELIERS.

TO VIEW THE ENTIRE COLLECTION, SEE OUR FULL-LINE CATALOG
OR VISIT US ONLINE AT FREDRICKRAMOND.COM

SHOWN: MONDO FR49299PCM 36" Diameter | 38.75" Height *This collection also features fixtures for bath.*

Bentley™

This sophisticated collection features seven styles in a Brushed Bronze finish with off-white, cinnamon-trimmed silk shades and delicate crystal accents.



SHOWN: BENTLEY FR44508BBZ 35" Diameter | 30.5" Height

See the entire Fredrick Ramond collection and complete product specifications online or in our full-line catalog.

FREDRICKRAMOND.COM

Alexandra™

This elegant collection features six styles in a Polished Nickel finish and is adorned with delicate crystal embellishments.



SHOWN: ALEXANDRA FR43628PNI 36.5" Diameter | 36" Height

See the entire Fredrick Ramond collection and complete product specifications online or in our full-line catalog.

FREDRICKRAMOND.COM

Opus™

This pseudo-retro collection featuring five styles infuses a distinctly modern attitude with retro character featuring a Black Chrome finish and egg-shaped etched opal glass. Also available in Brushed Nickel. Varying glass and shade options, including colored art glass are available.



SHOWN: OPUS FR45735BCM 29" Diameter | 19" Body Height, 57.75" Maximum Height

See the entire Fredrick Ramond collection and complete product specifications online or in our full-line catalog.

FREDRICKRAMOND.COM

Xanadu™

This showstopping collection features seven styles in a Polished Stainless Steel finish complemented by clear crystal accents.



SHOWN: XANADU FR43358PSS 41" Diameter | 42.25" Height

See the entire Fredrick Ramond collection and complete product specifications online or in our full-line catalog.

FREDRICKRAMOND.COM

Barcelona™

This collection embodies the essence of classically influenced design, featuring ten styles in a French Marble finish, complemented by tinted natural alabaster and a sophisticated array of crystal accents.



SHOWN: BARCELONA FR441O7FRM 42.25" Diameter | 63.5" Height

See the entire Fredrick Ramond collection and complete product specifications online or in our full-line catalog.

FREDRICKRAMOND.COM

Carabel™

This elegant collection is available in six styles featuring flourishing metalwork in a Brushed Champagne finish with inset ivory linen shades and etched diffusers.



SHOWN: CARABEL FR44626BCH 38.5" Diameter | 32" Height | 24" Depth

See the entire Fredrick Ramond collection and complete product specifications online or in our full-line catalog.

FREDRICKRAMOND.COM

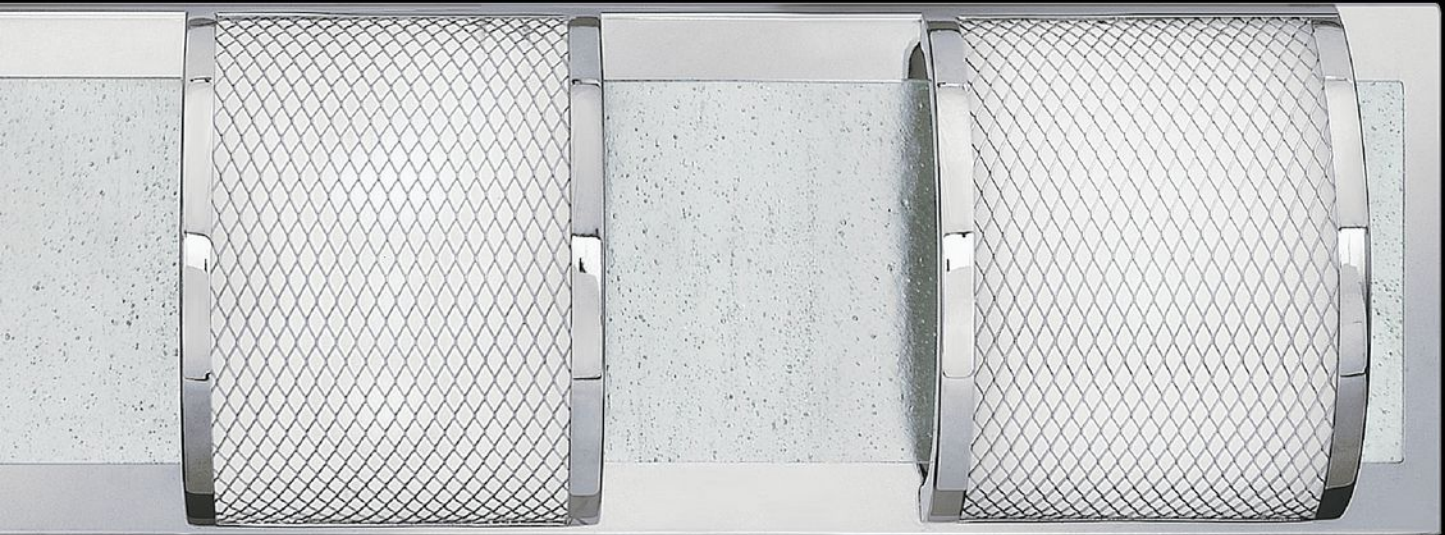

Mira mesh[™]

This sleek contemporary collection features four styles with three alternate shade options in a reflective Polished Chrome finish. Mira Mesh is accented with clear seedy glass on the back plate and etched glass-lined mesh-textured rounded shades.



BATH

THESE FEATURED COLLECTIONS BRILLIANTLY REFLECT THE FREDRICK RAMOND LEGACY

FREDRICK RAMOND FEATURES BATH COLLECTIONS THAT BLEND AMBIANCE, LUXURY AND DESIGN, CREATING THE ULTIMATE SPA EXPERIENCE. FREDRICK RAMOND BATH ENHANCES THIS RETREAT OF INDULGENCE AND REJUVENATION BY OFFERING ARTFUL, ARCHITECTURAL DESIGNS THAT TRANSFORM THIS ROOM INTO AN OASIS OF CHIC. EXPERIENCE FREDRICK RAMOND BATH.

TO VIEW THE ENTIRE COLLECTION, SEE OUR FULL-LINE CATALOG
OR VISIT US ONLINE AT FREDRICKRAMOND.COM

SHOWN: MIRA MESH FR5656OPCM 6" Width | 16.25" Height

Milan™

This sleek collection features four styles in a Polished Chrome finish adorned with black chrome ornaments and etched opal glass. Also available in Brushed Nickel.



SHOWN: MILAN FR52123PCM 24.25" Width | 7.25" Height

See the entire Fredrick Ramond collection and complete product specifications online or in our full-line catalog.

FREDRICKRAMOND.COM

BATH

LAYERING WITH LIGHT



"I think all types of lighting are important to consider in creating a spa-like feel in your bath."

- REBECCA TIER SOSKIN

A la Mode	219	Brooke	229	Josie	232	Plantation	249-250
Abbie	216-218	Bryanna	195	Lanza	220-221	Plymouth	239
Addison	233	Cari	194	Lola	200	Portofino	240
Alice	214-215	Carina	234	Meridian	190-191	Shelly	210-211
Anna	235	Casa	243	Miley	225-227	Stowe	241
Ashbury	203	Daphne	222-224	Nico	198	Taylor	196-197
Ashley	199	Devon	208-209	Ocho	202	Thistledown	242
Avery	201	Element	228	Olivia	230	Zoe	212
Avon	206-207	Flynn	244	Orb	193		
Bloom	231	Francoise	247-248	Pia	192		
Bolla	236-238	Isabella	245-246	Pinnacle	204-205		

layering light IN THE BATH

"I prefer to utilize multiple kinds of lighting in the bath. The look of a beautiful wall-mounted sconce keeps the bathroom classic and functional (this gives you a light source near your face). A ceiling mount or chandelier adds general lighting for the bathroom as well as adding a point of interest on the ceiling."

– Sara Gilbane Sullivan

LIGHTING IS CRUCIAL TO HOW WELL YOUR BATHROOM FUNCTIONS, NOT JUST HOW GOOD IT LOOKS. WHETHER YOU'RE BUILDING A NEW HOME OR REMODELING YOUR CURRENT SPACE, TODAY'S BATHROOMS SHOULD BE DESIGNED TO REFLECT YOUR PERSONAL STYLE AND INCLUDE WELL-PLANNED LIGHTING. LAYERING LIGHT IN THE BATHROOM IS THE BEST WAY TO PROVIDE TASK LIGHTING AS WELL AS AMBIENT LIGHTING, STRIKING JUST THE RIGHT BALANCE BETWEEN FUNCTION AND MOOD. Consider your options:

TASK LIGHTING

Task lighting provides adequate light for grooming, such as applying makeup and shaving. The best task lighting at the mirror is a pair of fixtures mounted on the wall, flanking the sink. This is called cross-illumination and provides shadow-free lighting for the face.

AMBIENT LIGHTING

Ambient lighting is achieved by bouncing the light off the ceiling, which softens shadows and creates a flattering effect.

ACCENT LIGHTING

Accent lighting gives depth and dimension to a bathroom, allowing you to illuminate design features, including art, architectural elements or even beautiful tile.

DECORATIVE LIGHTING

Decorative lighting, created by hanging eye-catching fixtures from the ceiling, will dress up the bath and add a layer of luxury.





perfect REFLECTION

When lighting your bathroom, one of the areas requiring the most attention should be on vanity lighting. Ideally fixtures should be mounted on either side of a central mirror. This allows for light to be evenly distributed across your face. The fixtures should be mounted at eye level and approximately 36-40" apart. This helps to eliminate shadows under the eyes and chin.

When installing fixtures on either side of the mirror is not optimal due to size and installation constraints, the next best option is to install fixtures directly over the vanity (approximately 75-80" above the floor). In certain cases, horizontal fixtures can be used in conjunction with the vertical lights to give additional overall illumination to the space.

Fixtures shown on page 181: Shelly 5010 CM, page 210
 Fixtures shown on page 182: Lanza 5100 AN, page 220;
 Hampton 3207 AN, page 64
 Fixtures shown above: Addison 5860 PL, page 233



“I think all types of lighting are important to consider in creating a spa-like feel in your bath. You want the element of romance, an element of chic and an element of functionality.”

- Rebecca Tier Soskin

beauty ILLUMINATED

A bare minimum of 150 watts of light should be used in lighting the vanity and it is always safer to err on the side of too much wattage. In cases where you find that there is too much light, either use lower wattage bulbs or install a dimmer. It is always easier to reduce the wattage of a fixture than to figure out how to increase the amount of light once the fixture is installed.



POWDER ROOM *perfection*

The powder room, typically a main floor half-bath, is often the home's smallest room. Yet, if you measure its worth by the amount of traffic a room gets per square foot, the powder room could easily be the most valuable space in your house. For this reason, you'll want to make sure you get the design right, especially the lighting, which can contribute dramatically to the overall effect of your space. Don't be afraid to get creative and express your personal style. Choose lighting fixtures with character that will provide both task and ambient lighting while adding a little something special to the decor.

"Powder rooms are the jewel boxes of a home. No rules apply. I love playing with scale – it can easily add drama and interest to a smaller space."

– Carrie Fundingsland

SOOTHING *sanctuary*

Adequate bathroom lighting is not only essential for grooming, but the bathroom is becoming a sanctuary where you can relax and recharge. Creating a space that feels comfortable and imparts a feeling that's clean and inviting can set the right mood for a spa-like retreat. As the bathroom increasingly becomes a place to relax and recharge, complete with luxurious amenities like a steam shower, spa tub or a fireplace, the lighting requires extra thought. And when it's done right, the payoff is great. After all, this is the room where you start and end your day. Just don't forget to follow the simple rules of form and function.

"In this case, all aspects of the lighting must be well thought out and executed. No one will enjoy a "spa" experience if they cannot see well or if they don't look fabulous when looking in the mirror! So, you need to use a combination of task lighting (especially at the sinks and make-up areas), as well as ambient and mood lighting in order to create the desired relaxation that one needs in a spa environment. Also, you want to avoid seeing the source of the lights – so using diffusers and shades is important – nothing will kill a relaxing mood more quickly than being stunned with the "burn" of a light bulb in your eyes. Dimmers are also key."

– Lisa Rachelle McDennon



"The most important element to creating a spa-like or relaxed environment in the bath is control. Several lighting situations and dimmers are a must when creating this type of atmosphere."

– Carrie Fundingsland



choose your PALETTE

It's important to take into consideration your color scheme, including the finish of your bath fixtures. Light, bright colors can give the illusion of more space plus add that crisp, clean feel while warm brushed gold or bronze finishes can add that timeless, classic feel.

~*~

"I always think bathrooms should feel fresh and clean so my color schemes always sway that way. I like the lighting finishes and metals to coordinate – so shiny, crisp lighting is always my go-to."

- Kyle Schuneman -



make a STATEMENT

In a small space like a bathroom or powder room, you have the opportunity to make a strong design statement to your guests and convey your home's unique personality. Choosing an intense wall or ceiling color, exotic wallpaper or hanging an interesting chandelier can make a dramatic impact in the room and add an element of surprise off the hallway.

~*~

"Scale is definitely important. If your ceilings are low then a large lighting fixture won't work even if you are trying to create drama. Instead of finding something large, find something with intricate details to create that drama and interest."

- Kyle Schuneman -

ENLIGHTENED

ALONG WITH THE OTHER TYPES OF LIGHT THAT ARE IMPORTANT IN THE BATHROOM, INCLUDING TASK AND ACCENT LIGHTING, NATURAL LIGHT SHOULD NOT BE FORGOTTEN. SUNLIGHT IS OBVIOUSLY ENERGY EFFICIENT AND PROVIDES A WELCOMING FEEL OF OPENNESS AND FRESHNESS TO A SMALL SPACE.

"I love natural light EVERYWHERE — for me, it is the most important starting point of a project, understanding how it affects each room — it is the KEY to why we feel a particular way in any space. With regard to bathrooms — natural light is so critical — and fixtures that mimic natural light, those using halogen bulbs, are always my preference."

– Jill Sharp Brinson



INCANDESCENT VS. HALOGEN *in the bath*

Both incandescent and halogen bulbs are viable options for the bath. Fixtures that feature halogen bulbs typically have a lower-profile, and can feature a more contemporary design since the bulbs themselves are smaller than incandescent. It is true that halogen bulbs give off a brighter, whiter light than their counterparts (incandescent), so it's simply a personal choice as to what kind of light you want to see yourself in.

MERIDIAN™

- Finish** Chrome
- Glass** Thick faceted clear inside etched
- Details** Low profile ½" thick glass; cast over-scaled barrel knobs
- See also** Meridian chandeliers, pages 44-45



(top view of glass showing ½" thickness)



3871 CM



5592 CM



5593 CM



5594 CM



5590 CM



MERIDIAN

Chrome (CM)

ITEM	WIDTH/DIA.	HEIGHT	EXT.	TOP TO OUTLET	BACK PLATE/CANOPY	BULBS	AVAILABLE FINISHES
3871 CM	16" Dia.	12¼"			5½" Dia. Canopy	3-60w G9*	BN, CM
5590 CM	5" W	8"	6½"	4"	4½" W, 8" H Back Plate	1-60w G9*	BN, CM
5592 CM	14" W	6"	6¼"	3¾"	8" W, 4½" H Back Plate	2-60w G9*	BN, CM
5593 CM	21" W	6"	6¼"	3¾"	8" W, 4½" H Back Plate	3-60w G9*	BN, CM
5594 CM	29" W	6"	6¼"	3¾"	8" W, 4½" H Back Plate	4-60w G9*	BN, CM

*G9 halogen bulbs included.

MERIDIAN™



3871 BN

- Finish** Brushed Nickel
- Glass** Thick faceted clear inside etched
- Details** Low profile ½" thick glass; cast over-scaled barrel knobs
- See also** Meridian chandeliers, pages 44-45



(top view of glass showing ½" thickness)



5593 BN



5592 BN



5590 BN



5594 BN

MERIDIAN		Brushed Nickel (BN)					
ITEM	WIDTH/DIA.	HEIGHT	EXT.	TOP TO OUTLET	BACK PLATE/CANOPY	BULBS	AVAILABLE FINISHES
3871 BN	16" Dia.	12¼"			5½" Dia. Canopy	3-60w G9*	BN, CM
5590 BN	5" W	8"	6½"	4"	4½" W, 8" H Back Plate	1-60w G9*	BN, CM
5592 BN	14" W	6"	6¼"	3¾"	8" W, 4½" H Back Plate	2-60w G9*	BN, CM
5593 BN	21" W	6"	6¼"	3¾"	8" W, 4½" H Back Plate	3-60w G9*	BN, CM
5594 BN	29" W	6"	6¼"	3¾"	8" W, 4½" H Back Plate	4-60w G9*	BN, CM



*G9 halogen bulbs included.

PIA™

- Finish** Brushed Nickel with Chrome accents
- Glass** Thick scalloped inside etched
- Details** Petite design with 3/8" thick glass; ADA compliant



(top view of glass showing 3/8" thickness)



5172 BN



5173 BN



5170 BN



5174 BN



PIA

Brushed Nickel (BN)

ITEM	WIDTH/DIA.	HEIGHT	EXT.	TOP TO OUTLET	BACK PLATE/CANOPY	BULBS	AVAILABLE FINISHES
5170 BN	4½" W	7"	4"	3"	4½" W, 7" H Back Plate	1-60w G9*	BN
5172 BN	12½" W	5½"	3"	3"	8" W, 4½" H Back Plate	2-60w G9*	BN
5173 BN	20" W	5½"	3"	3"	8" W, 4½" H Back Plate	3-60w G9*	BN
5174 BN	27" W	5½"	3"	3"	8" W, 4½" H Back Plate	4-60w G9*	BN

*G9 halogen bulbs included. For flush mount options, see pages 15-16.

ORB™

Finish Chrome
Glass Thick inside scalloped and etched
Details Petite design with 5/8" thick glass; mounting bars are curved in shape



5132 CM



5133 CM



(mounting bars are curved in shape)



(top view of glass showing 5/8" thickness)



5130 CM



5134 CM



5135 CM

ORB		Chrome (CM)					
ITEM	WIDTH/DIA.	HEIGHT	EXT.	TOP TO OUTLET	BACK PLATE/CANOPY	BULBS	AVAILABLE FINISHES
5130 CM	6" W	7"	5/8"	3 1/2"	4 1/4" W, 7" H Back Plate	1-60w G9**	CM
5132 CM*	15 1/4" W	4 1/2"	4 3/4"	2 1/4"	7" W, 4 1/2" H Back Plate	2-60w G9**	CM
5133 CM*	23" W	4 1/2"	5"	2 1/4"	7" W, 4 1/2" H Back Plate	3-60w G9**	CM
5134 CM*	30 1/2" W	4 1/2"	5"	2 1/4"	7" W, 4 1/2" H Back Plate	4-60w G9**	CM
5135 CM*	36 3/4" W	4 1/2"	5"	2 1/4"	7" W, 4 1/2" H Back Plate	5-60w G9**	CM



*Mounting bar is curved in shape. **G9 halogen bulbs included. For flush mount options, see pages 15-16.

CARI™

- Finish** Chrome
- Glass** Ribbed etched opal
- Details** Low profile oval shaped glass



5421 CM



5522 CM



5523 CM



5524 CM



5520 CM



CARI

Chrome (CM)

ITEM	WIDTH/DIA.	HEIGHT	EXT.	TOP TO OUTLET	BACK PLATE/CANOPY	BULBS	AVAILABLE FINISHES
5421 CM**	17" Dia.	7"				3-60w Med.	BN, BR, CM, OZ
5520 CM	9" W	5¼"	5"	2¾"	9" W, 5" H Back Plate	1-60w G9*	CM
5522 CM	18¾" W	5¼"	6½"	2¾"	9" W, 5" H Back Plate	2-60w G9*	CM
5523 CM	27½" W	5¼"	6½"	2¾"	9" W, 5" H Back Plate	3-60w G9*	CM
5524 CM	37½" W	5¼"	6½"	2¾"	9" W, 5" H Back Plate	4-60w G9*	CM

*G9 halogen bulbs included. **Recommended companion flush mount. For additional options, see pages 15-16.

BRYANNA™

- Finish** Chrome
- Glass** Thick inside frosted and ribbed
- Details** Petite design with oval shaped tubing



5421 CM



(top view of glass showing 1/4" thickness)



5083 CM



5082 CM



5080 CM



5084 CM

BRYANNA		Chrome (CM)					
ITEM	WIDTH/DIA.	HEIGHT	EXT.	TOP TO OUTLET	BACK PLATE/CANOPY	BULBS	AVAILABLE FINISHES
5080 CM	5½" W	7½"	5"	2¾"	4½" W, 7¼" H Back Plate	1-60w G9*	CM
5082 CM	15¾" W	5½"	5½"	2¾"	7¼" W, 4½" H Back Plate	2-60w G9*	CM
5083 CM	24¾" W	5½"	5½"	2¾"	7¼" W, 4½" H Back Plate	3-60w G9*	CM
5084 CM	33¾" W	5½"	5½"	2¾"	7¼" W, 4½" H Back Plate	4-60w G9*	CM
5421 CM**	17" Dia.	7"				3-60w Med.	BN, BR, CM, OZ



*G9 halogen bulbs included. **Recommended companion flush mount. For additional options, see pages 15-16.

TAYLOR™

Finish Chrome
Glass Etched white
Details Tapered rectangular glass; mounting hardware hidden on back plate



5551 CM



5022 CM



5023 CM



5024 CM



5020 CM



5025 CM **INV**



TAYLOR

Chrome (CM)

ITEM	WIDTH/DIA.	HEIGHT	EXT.	TOP TO OUTLET	BACK PLATE/CANOPY	BULBS	AVAILABLE FINISHES
5020 CM	7¾" W	6"	5¼"	3¾"	7¾" W, 4¾" H Back Plate	1-60w G9*	BN, CM
5022 CM	18¾" W	6"	5½"	3¾"	7¾" W, 4¾" H Back Plate	2-60w G9*	BN, CM
5023 CM	27½" W	6"	5½"	3¾"	7¾" W, 4¾" H Back Plate	3-60w G9*	BN, CM
5024 CM	36¼" W	6"	5½"	3¾"	7¾" W, 4¾" H Back Plate	4-60w G9*	BN, CM
5025 CM	45" W	7"	5½"	5"	12" W, 4¾" H Back Plate	5-60w G9*	BN, CM
5551 CM**	15" Dia.	7¾"				2-60w Med.	BN, CM

*G9 halogen bulbs included. **Recommended companion flush mount. For additional options, see pages 15-16.

TAYLOR™



5551 BN

Finish Brushed Nickel
Glass Etched white
Details Tapered rectangular glass; mounting hardware hidden on back plate



5023 BN



5022 BN



5020 BN



5024 BN



5025 BN **INV**

TAYLOR

Brushed Nickel (BN)

ITEM	WIDTH/DIA.	HEIGHT	EXT.	TOP TO OUTLET	BACK PLATE/CANOPY	BULBS	AVAILABLE FINISHES
5020 BN	7¾" W	6"	5¼"	3¾"	7¾" W, 4¾" H Back Plate	1-60w G9*	BN, CM
5022 BN	18¾" W	6"	5½"	3¾"	7¾" W, 4¾" H Back Plate	2-60w G9*	BN, CM
5023 BN	27½" W	6"	5½"	3¾"	7¾" W, 4¾" H Back Plate	3-60w G9*	BN, CM
5024 BN	36¼" W	6"	5½"	3¾"	7¾" W, 4¾" H Back Plate	4-60w G9*	BN, CM
5025 BN	45" W	7"	5½"	5"	12" W, 4¾" H Back Plate	5-60w G9*	BN, CM
5551 BN**	15" Dia.	7¾"				2-60w Med.	BN, CM



*G9 halogen bulbs included. **Recommended companion flush mount. For additional options, see pages 15-16.

NICO™

Finish Brushed Nickel
Glass Etched opal
Details Tapered rectangular glass; angled mounting bars



5551 BN



5502 BN



5503 BN



5504 BN



5500 BN



5505 BN



NICO

Brushed Nickel (BN)

ITEM	WIDTH/DIA.	HEIGHT	EXT.	TOP TO OUTLET	BACK PLATE/CANOPY	BULBS	AVAILABLE FINISHES
5500 BN	5¼" W	7½"	5¼"	4"	4½" W, 7" H Back Plate	1-60w G9*	BN
5502 BN	14½" W	7¼"	5¼"	5"	7" W, 4½" H Back Plate	2-60w G9*	BN
5503 BN	23¾" W	7¼"	5¼"	5"	7" W, 4½" H Back Plate	3-60w G9*	BN
5504 BN	33" W	7¼"	5¼"	5"	7" W, 4½" H Back Plate	4-60w G9*	BN
5505 BN	42" W	7¼"	5¼"	5"	10" W, 4½" H Back Plate	5-60w G9*	BN
5551 BN**	15" Dia.	7¾"				2-60w Med.	BN

*G9 halogen bulbs included. **Recommended companion flush mount. For additional options, see pages 15-16.

ASHLEY™

Finish Chrome
Glass Etched opal; stepped trim detail
Details Cast perforated glass holders



5191 CM



5193 CM



5192 CM



5190 CM



5194 CM

ASHLEY

Chrome (CM)

ITEM	WIDTH/DIA.	HEIGHT	EXT.	TOP TO OUTLET	BACK PLATE/CANOPY	BULBS	AVAILABLE FINISHES
5190 CM	5" W	8½"	6¼"	4¼"	5" W, 8½" H Back Plate	1-100w Med.	CM
5191 CM*	15¾" Dia.	7"				3-60w Med.	CM
5192 CM	12¾" W	7¼"	6¼"	4¾"	8½" W, 5" H Back Plate	2-100w Med.	CM
5193 CM	19¼" W	7¼"	6¼"	4¾"	8½" W, 5" H Back Plate	3-100w Med.	CM
5194 CM	26¾" W	7¼"	6¼"	4¾"	8½" W, 5" H Back Plate	4-100w Med.	CM

*Recommended companion flush mount. For additional options, see pages 15-16.



LOLA™

- Finish** Brushed Nickel
- Glass** Thick clear inside etched
- Details** Cube-shaped ¼" thick glass; floating raceway back plate

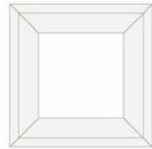

(top view of glass showing ¼" thickness)



5772 BN



5773 BN



5770 BN



5774 BN



LOLA

Brushed Nickel (BN)

ITEM	WIDTH/DIA.	HEIGHT	EXT.	TOP TO OUTLET	BACK PLATE/CANOPY	BULBS	AVAILABLE FINISHES
5770 BN	5½" W	10"	5¼"	5"	4½" W, 9" H Back Plate	1-60w G9*	BN
5772 BN	14" W	5½"	5¼"	2¾"	11" W, 4½" H Back Plate	2-60w G9*	BN
5773 BN	23" W	5½"	5¼"	2¾"	20" W, 4½" H Back Plate	3-60w G9*	BN
5774 BN	32" W	5½"	5¼"	2¾"	29¼" W, 4½" H Back Plate	4-60w G9*	BN

*G9 halogen bulbs included. The Lola family must be hung with sockets facing upright. For flush mount options, see pages 15-16.

Finish Brushed Nickel
Glass Etched opal
Details Pyramid-shaped cast glass holders; raceway back plate; mounting hardware hidden on back plate



5421 BN



5213 BN INV



5212 BN INV



5210 BN INV



5214 BN INV

AVERY		Brushed Nickel (BN)					
ITEM	WIDTH/DIA.	HEIGHT	EXT.	TOP TO OUTLET	BACK PLATE/CANOPY	BULBS	AVAILABLE FINISHES
5210 BN	6½" W	6¼"	5¾"	3¼"	4½" W, 6" H Back Plate	1-100w Med.	BN
5212 BN	16" W	6¼"	5¾"	3¾"	16" W, 5" H Back Plate	2-100w Med.	BN
5213 BN	24" W	6¼"	5¾"	3¾"	24" W, 5" H Back Plate	3-100w Med.	BN
5214 BN	32" W	6¼"	5¾"	3¾"	32" W, 5" H Back Plate	4-100w Med.	BN
5421 BN*	17" Dia.	7"				3-60w Med.	BN, BR, CM, OZ



*Recommended companion flush mount. For additional options, see pages 15-16.

OCHO™

Finish Chrome
Glass Etched opal
Details Oval shaped glass; mounting hardware hidden on back plate



5421 CM



5422 CM INV



5423 CM INV



5424 CM INV



5420 CM INV



OCHO

Chrome (CM)

ITEM	WIDTH/DIA.	HEIGHT	EXT.	TOP TO OUTLET	BACK PLATE/CANOPY	BULBS	AVAILABLE FINISHES
5420 CM	6" W	6"	5¼"	4¼"	6" W, 5¼" H Back Plate	1-75w G9*	CM
5421 CM	17" Dia.	7"				3-60w Med.	BN, BR, CM, OZ
5422 CM	13½" W	7"	5¼"	4½"	6" W, 5¼" H Back Plate	2-75w G9*	CM
5423 CM	21" W	7"	5¼"	4½"	6" W, 5¼" H Back Plate	3-75w G9*	CM
5424 CM	28½" W	7"	5¼"	4½"	6" W, 5¼" H Back Plate	4-75w G9*	CM

*G9 halogen bulbs included. For flush mount options, see pages 15-16.

ASHBURY™

Finish Chrome
Glass Etched opal
Details Faceted crystal bobesches
See also Ashbury chandeliers, pages 46-47



5421 CM



5703 CM



5702 CM



5700 CM



5704 CM

ASHBURY		Chrome (CM)					
ITEM	WIDTH/DIA.	HEIGHT	EXT.	TOP TO OUTLET	BACK PLATE/CANOPY	BULBS	AVAILABLE FINISHES
5421 CM**	17" Dia.	7"				3-60w Med.	BN, BR, CM, OZ
5700 CM	6" W	8"	7¾"	4"	4¾" W, 8" H Back Plate	1-60w G9*	CM
5702 CM	15½" W	5¾"	8"	2½"	8" W, 4¾" H Back Plate	2-60w G9*	CM
5703 CM	25" W	5¾"	8"	2½"	8" W, 4¾" H Back Plate	3-60w G9*	CM
5704 CM	34½" W	5¾"	8"	2½"	8" W, 4¾" H Back Plate	4-60w G9*	CM



*G9 halogen bulbs included. **Recommended companion flush mount. For additional options, see pages 15-16.

PINNACLE™

Finish Chrome with Antique Nickel accents
Glass Etched opal
Details Mounting bars are curved in shape; cast square decorative medallions



5251 CM



5252 CM



(mounting bars are curved in shape)



5253 CM



5254 CM



5250 CM



5255 CM



PINNACLE

Chrome (CM)

ITEM	WIDTH/DIA.	HEIGHT	EXT.	TOP TO OUTLET	BACK PLATE/CANOPY	BULBS	AVAILABLE FINISHES
5250 CM	5" W	9"	7¼"	4½"	4½" W, 9" H Back Plate	1-100w Med.	AN, CM
5251 CM	16¼" Dia.	7¼"				3-60w Med.	AN, CM
5252 CM*	14" W	8"	6"	5¾"	7¼" W, 4½" H Back Plate	2-100w Med.	AN, CM
5253 CM*	21" W	8"	7¼"	5¾"	9" W, 4½" H Back Plate	3-100w Med.	AN, CM
5254 CM*	29" W	8"	7¼"	5¾"	9" W, 4½" H Back Plate	4-100w Med.	AN, CM
5255 CM*	37" W	8"	7¼"	5¾"	9" W, 4½" H Back Plate	5-100w Med.	AN, CM

*Mounting bar is curved in shape.

PINNACLE™

Finish Antique Nickel
Glass Clear etched
Details Mounting bars are curved in shape; cast square decorative medallions



5251 AN



5253 AN



(mounting bars are curved in shape)



5252 AN



5250 AN



5254 AN



5255 AN

PINNACLE		Antique Nickel (AN)						
ITEM	WIDTH/DIA.	HEIGHT	EXT.	TOP TO OUTLET	BACK PLATE/CANOPY	BULBS	AVAILABLE FINISHES	
5250 AN	5" W	9"	7¼"	4½"	4½" W, 9" H Back Plate	1-100w Med.	AN, CM	
5251 AN	16¼" Dia.	7¼"				3-60w Med.	AN, CM	
5252 AN*	14" W	8"	6"	5¾"	7¼" W, 4½" H Back Plate	2-100w Med.	AN, CM	
5253 AN*	21" W	8"	7¼"	5¾"	9" W, 4½" H Back Plate	3-100w Med.	AN, CM	
5254 AN*	29" W	8"	7¼"	5¾"	9" W, 4½" H Back Plate	4-100w Med.	AN, CM	
5255 AN*	37" W	8"	7¼"	5¾"	9" W, 4½" H Back Plate	5-100w Med.	AN, CM	



*Mounting bar is curved in shape.

AVON™

Finish Chrome
 Glass Cased opal
 Details Cast detailing



5551 CM



5552 CM



5553 CM



5554 CM



5550 CM



5556 CM



AVON

Chrome (CM)

ITEM	WIDTH/DIA.	HEIGHT	EXT.	TOP TO OUTLET	BACK PLATE/CANOPY	BULBS	AVAILABLE FINISHES
5550 CM	7¼" W	7½"	6¼"	5¼"	7¼" W, 4½" H Back Plate	1-75w Med.	BN, CM
5551 CM	15" Dia.	7¾"				2-60w Med.	BN, CM
5552 CM	14½" W	8"	6¼"	5¾"	7¼" W, 4½" H Back Plate	2-75w Med.	BN, CM
5553 CM	23" W	8"	6¼"	5¾"	7¼" W, 4½" H Back Plate	3-75w Med.	BN, CM
5554 CM	31¾" W	8"	6¼"	5¾"	7¼" W, 4½" H Back Plate	4-75w Med.	BN, CM
5556 CM	48" W	8"	6¼"	5¾"	18" W, 4½" H Back Plate	6-75w Med.	BN, CM

AVON™

Finish Brushed Nickel
 Glass Etched opal
 Details Cast detailing



5551 BN



5553 BN



5552 BN



5550 BN



5554 BN



5556 BN

AVON

Brushed Nickel (BN)

ITEM	WIDTH/DIA.	HEIGHT	EXT.	TOP TO OUTLET	BACK PLATE/CANOPY	BULBS	AVAILABLE FINISHES
5550 BN	7¼" W	7½"	6¼"	5¼"	7¼" W, 4½" H Back Plate	1-75w Med.	BN, CM
5551 BN	15" Dia.	7¾"				2-60w Med.	BN, CM
5552 BN	14½" W	8"	6¼"	5¾"	7¼" W, 4½" H Back Plate	2-75w Med.	BN, CM
5553 BN	23" W	8"	6¼"	5¾"	7¼" W, 4½" H Back Plate	3-75w Med.	BN, CM
5554 BN	31¾" W	8"	6¼"	5¾"	7¼" W, 4½" H Back Plate	4-75w Med.	BN, CM
5556 BN	48" W	8"	6¼"	5¾"	18" W, 4½" H Back Plate	6-75w Med.	BN, CM



DEVON™

Finish Chrome
Glass Ribbed etched opal
Details Arched oval mounting bars; over-scaled tapered glass



5421 CM



5072 CM



5073 CM



5074 CM



5070 CM



DEVON

Chrome (CM)

ITEM	WIDTH/DIA.	HEIGHT	EXT.	TOP TO OUTLET	BACK PLATE/CANOPY	BULBS	AVAILABLE FINISHES
5070 CM	5½" W	8"	7½"	4½"	4¾" W, 6¾" H Back Plate	1-100w Med.	BN, CM
5072 CM	15½" W	8"	7½"	4½"	6¾" W, 4¾" H Back Plate	2-100w Med.	BN, CM
5073 CM	25" W	8"	7½"	4½"	6¾" W, 4¾" H Back Plate	3-100w Med.	BN, CM
5074 CM	34½" W	8"	7½"	4½"	6¾" W, 4¾" H Back Plate	4-100w Med.	BN, CM
5421 CM*	17" Dia.	7"				3-60w Med.	BN, BR, CM, OZ

*Recommended companion flush mount. For additional options, see pages 15-16.

DEVON™

Finish Brushed Nickel
Glass Ribbed etched opal
Details Arched oval mounting bars; over-scaled tapered glass



5421 BN



5073 BN



5072 BN



5070 BN



5074 BN

DEVON

Brushed Nickel (BN)

ITEM	WIDTH/DIA.	HEIGHT	EXT.	TOP TO OUTLET	BACK PLATE/CANOPY	BULBS	AVAILABLE FINISHES
5070 BN	5½" W	8"	7½"	4½"	4¾" W, 6¾" H Back Plate	1-100w Med.	BN, CM
5072 BN	15½" W	8"	7½"	4½"	6¾" W, 4¾" H Back Plate	2-100w Med.	BN, CM
5073 BN	25" W	8"	7½"	4½"	6¾" W, 4¾" H Back Plate	3-100w Med.	BN, CM
5074 BN	34½" W	8"	7½"	4½"	6¾" W, 4¾" H Back Plate	4-100w Med.	BN, CM
5421 BN*	17" Dia.	7"				3-60w Med.	BN, BR, CM, OZ

*Recommended companion flush mount. For additional options, see pages 15-16.



SHELLY™

Finish Chrome
Glass Etched opal
Details Decorative cast finials;
 six-sided fluted glass



5421 CM



5012 CM



5013 CM



5014 CM



5010 CM



SHELLY

Chrome (CM)

ITEM	WIDTH/DIA.	HEIGHT	EXT.	TOP TO OUTLET	BACK PLATE/CANOPY	BULBS	AVAILABLE FINISHES
5010 CM	5½" W	9½"	7½"	5"	4¾" W, 9" H Back Plate	1-100w Med.	BN, CM
5012 CM	16" W	8¼"	7¾"	4¼"	9" W, 4¾" H Back Plate	2-100w Med.	BN, CM
5013 CM	24" W	8¼"	7¾"	4¼"	9" W, 4¾" H Back Plate	3-100w Med.	BN, CM
5014 CM	32¼" W	8¼"	7¾"	4¼"	9" W, 4¾" H Back Plate	4-100w Med.	BN, CM
5421 CM*	17" Dia.	7"				3-60w Med.	BN, BR, CM, OZ

*Recommended companion flush mount. For additional options, see pages 15-16.

SHELLY™

Finish Brushed Nickel
Glass Etched opal
Details Decorative cast finials;
 six-sided fluted glass



5421 BN



5013 BN



5012 BN



5010 BN



5014 BN

SHELLY

Brushed Nickel (BN)

ITEM	WIDTH/DIA.	HEIGHT	EXT.	TOP TO OUTLET	BACK PLATE/CANOPY	BULBS	AVAILABLE FINISHES
5010 BN	5½" W	9½"	7½"	5"	4¾" W, 9" H Back Plate	1-100w Med.	BN, CM
5012 BN	16" W	8¾"	7¾"	4½"	9" W, 4¾" H Back Plate	2-100w Med.	BN, CM
5013 BN	24" W	8¾"	7¾"	4½"	9" W, 4¾" H Back Plate	3-100w Med.	BN, CM
5014 BN	32½" W	8¾"	7¾"	4½"	9" W, 4¾" H Back Plate	4-100w Med.	BN, CM
5421 BN*	17" Dia.	7"				3-60w Med.	BN, BR, CM, OZ

*Recommended companion flush mount. For additional options, see pages 15-16.



ZOE™

Finish Chrome
Glass Hammered etched
Details Trumpet-shaped glass



5421 CM



5982 CM



5983 CM



5984 CM



5980 CM



ZOE

Chrome (CM)

ITEM	WIDTH/DIA.	HEIGHT	EXT.	TOP TO OUTLET	BACK PLATE/CANOPY	BULBS	AVAILABLE FINISHES
5421 CM*	17" Dia.	7"				3-60w Med.	BN, BR, CM, OZ
5980 CM	5½" W	7¾"	6½"	5"	5" W, 5¼" H Back Plate	1-100w Med.	CM
5982 CM	13½" W	7¾"	6½"	5"	8½" W, 5¼" H Back Plate	2-100w Med.	CM
5983 CM	21¼" W	7¾"	6½"	5"	8½" W, 5¼" H Back Plate	3-100w Med.	CM
5984 CM	29¼" W	7¾"	6½"	5"	8½" W, 5¼" H Back Plate	4-100w Med.	CM

*Recommended companion flush mount. For additional options, see pages 15-16.



Fixture shown: Brooke 5003 AN, page 229

ALICE™

- Finish** Antique Nickel
- Glass** Etched opal
- Details** Decorative half-round turnings and coordinating finials; mounting hardware hidden on back plate



4371 PL



5832 AN INV



5833 AN INV



5834 AN INV



5830 AN INV

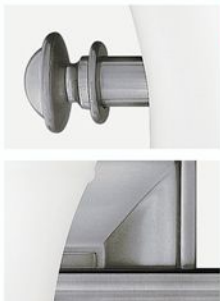

ALICE

Antique Nickel (AN)

ITEM	WIDTH/DIA.	HEIGHT	EXT.	TOP TO OUTLET	BACK PLATE/CANOPY	BULBS	AVAILABLE FINISHES
4371 PL*	15" Dia.	8½"				2-60w Med.	PL
5830 AN	5¼" W	8¾"	7½"	4"	5¼" W, 8" H Back Plate	1-100w Med.	AN, BR
5832 AN	17" W	8"	7½"	3¼"	8" W, 5¼" H Back Plate	2-100w Med.	AN, BR
5833 AN	27" W	8"	7½"	3¼"	8" W, 5¼" H Back Plate	3-100w Med.	AN, BR
5834 AN	36¾" W	8"	7½"	3¼"	8" W, 5¼" H Back Plate	4-100w Med.	AN, BR

*Recommended companion flush mount. For additional options, see pages 15-16.

ALICE™

Finish Brushed Bronze
Glass Etched opal
Details Decorative half-round turnings and coordinating finials; mounting hardware hidden on back plate



5551 BR



5833 BR INV



5832 BR INV



5830 BR INV



5834 BR INV

ALICE

Brushed Bronze (BR)

ITEM	WIDTH/DIA.	HEIGHT	EXT.	TOP TO OUTLET	BACK PLATE/CANOPY	BULBS	AVAILABLE FINISHES
5551 BR*	15" Dia.	7¾"				2-60w Med.	BR, CM
5830 BR	5¼" W	8¾"	7½"	4"	5¼" W, 8" H Back Plate	1-100w Med.	AN, BR
5832 BR	17" W	8"	7½"	3¼"	8" W, 5¼" H Back Plate	2-100w Med.	AN, BR
5833 BR	27" W	8"	7½"	3¼"	8" W, 5¼" H Back Plate	3-100w Med.	AN, BR
5834 BR	36¾" W	8"	7½"	3¼"	8" W, 5¼" H Back Plate	4-100w Med.	AN, BR

*Recommended companion flush mount. For additional options, see pages 15-16.

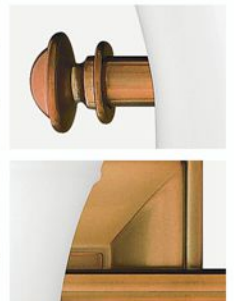

ABBIE™

Finish Chrome
Glass Etched
Details Square mounting bars;
 cast detailing



5421 CM



5852 CM



5853 CM



5854 CM



5850 CM



5855 CM



ABBIE

Chrome (CM)

ITEM	WIDTH/DIA.	HEIGHT	EXT.	TOP TO OUTLET	BACK PLATE/CANOPY	BULBS	AVAILABLE FINISHES
5421 CM*	17" Dia.	7"				3-60w Med.	BN, BR, CM, OZ
5850 CM	6¾" W	7¾"	7½"	4½"	4½" W, 6½" H Back Plate	1-100w Med.	BC, BN, CM
5852 CM	16" W	7¾"	7½"	5¼"	6½" W, 4½" H Back Plate	2-100w Med.	BC, BN, CM
5853 CM	25½" W	7¾"	7½"	5¼"	6½" W, 4½" H Back Plate	3-100w Med.	BC, BN, CM
5854 CM	34½" W	7¾"	7½"	5¼"	6½" W, 4½" H Back Plate	4-100w Med.	BC, BN, CM
5855 CM	43¾" W	7¾"	7½"	5¼"	6½" W, 4½" H Back Plate	5-100w Med.	BC, BN, CM

*Recommended companion flush mount. For additional options, see pages 15-16.

ABBIE™

Finish Brushed Nickel
Glass Etched
Details Square mounting bars; cast detailing



5421 BN



5853 BN



5852 BN



5850 BN



5854 BN



5855 BN

ABBIE

Brushed Nickel (BN)

ITEM	WIDTH/DIA.	HEIGHT	EXT.	TOP TO OUTLET	BACK PLATE/CANOPY	BULBS	AVAILABLE FINISHES
5421 BN*	17" Dia.	7"				3-60w Med.	BN, BR, CM, OZ
5850 BN	6¾" W	7¾"	7½"	4½"	4½" W, 6½" H Back Plate	1-100w Med.	BC, BN, CM
5852 BN	16" W	7¾"	7½"	5¼"	6½" W, 4½" H Back Plate	2-100w Med.	BC, BN, CM
5853 BN	25¼" W	7¾"	7½"	5¼"	6½" W, 4½" H Back Plate	3-100w Med.	BC, BN, CM
5854 BN	34½" W	7¾"	7½"	5¼"	6½" W, 4½" H Back Plate	4-100w Med.	BC, BN, CM
5855 BN	43¾" W	7¾"	7½"	5¼"	6½" W, 4½" H Back Plate	5-100w Med.	BC, BN, CM



*Recommended companion flush mount. For additional options, see pages 15-16.

ABBIE™

Finish Brushed Caramel
Glass Etched
Details Square mounting bars;
 cast detailing



5421 BR



5852 BC



5853 BC



5854 BC



5850 BC



5855 BC



ABBIE

Brushed Caramel (BC)

ITEM	WIDTH/DIA.	HEIGHT	EXT.	TOP TO OUTLET	BACK PLATE/CANOPY	BULBS	AVAILABLE FINISHES
5421 BR*	17" Dia.	7"				3-60w Med.	BN, BR, CM, OZ
5850 BC	6¾" W	7¾"	7½"	4½"	4½" W, 6½" H Back Plate	1-100w Med.	BC, BN, CM
5852 BC	16" W	7¾"	7½"	5¼"	6½" W, 4½" H Back Plate	2-100w Med.	BC, BN, CM
5853 BC	25½" W	7¾"	7½"	5¼"	6½" W, 4½" H Back Plate	3-100w Med.	BC, BN, CM
5854 BC	34½" W	7¾"	7½"	5¼"	6½" W, 4½" H Back Plate	4-100w Med.	BC, BN, CM
5855 BC	43¾" W	7¾"	7½"	5¼"	6½" W, 4½" H Back Plate	5-100w Med.	BC, BN, CM

*Recommended companion flush mount. For additional options, see pages 15-16.

A LA MODE™

Finish Brushed Nickel or Brushed Bronze
Glass Etched opal
Details Peanut shaped glass; large cast barrel shaped lock-up



5421 BR



5421 BN



5066 BN



5062 BN



5064 BN



5064 BR



5062 BR



5066 BR

A LA MODE

Brushed Nickel (BN) or Brushed Bronze (BR)

ITEM	WIDTH/DIA.	HEIGHT	EXT.	TOP TO OUTLET	BACK PLATE/CANOPY	BULBS	AVAILABLE FINISHES
5062 BN, 5062 BR	8" W	8"	4¼"	4"	4¾" W, 8" H Back Plate	2-40w G9*	BN, BR
5064 BN, 5062 BR	17¾" W	4¾"	4¼"	2½"	7¾" W, 4¾" H Back Plate	4-40w G9*	BN, BR
5066 BN, 5062 BR	27¼" W	4¾"	4¼"	2½"	7¾" W, 4¾" H Back Plate	6-40w G9*	BN, BR
5421 BN, 5421 BR**	17" Dia.	7"				3-60w Med.	BN, BR, CM, OZ

*G9 halogen bulbs included. **Recommended companion flush mount. For additional options, see pages 15-16.



LANZA™

Finish Antique Nickel
Glass Etched opal
Details Geometric patterned detailing; mounting hardware hidden on back plate



5421 BN



5100 AN



5104 AN INV



5102 AN INV



5103 AN INV



5105 AN INV



LANZA

Antique Nickel (AN)

ITEM	WIDTH/DIA.	HEIGHT	EXT.	TOP TO OUTLET	BACK PLATE/CANOPY	BULBS	AVAILABLE FINISHES
5100 AN	7¼" W	12"	5"	6½"	4¾" W, 12" H Back Plate	1-60w G9*	AN, BR
5102 AN	16½" W	6¾"	5"	4"	9" W, 4¾" H Back Plate	2-60w G9*	AN, BR
5103 AN	25" W	6¾"	5"	4"	12" W, 4¾" H Back Plate	3-60w G9*	AN, BR
5104 AN	34" W	6¾"	5"	4"	12" W, 4¾" H Back Plate	4-60w G9*	AN, BR
5105 AN	43" W	6¾"	5"	4"	12" W, 4¾" H Back Plate	5-60w G9*	AN, BR
5421 BN**	17" Dia.	7"				3-60w Med.	BN, BR, CM, OZ

*G9 halogen bulbs included. **Recommended companion flush mount. For additional options, see pages 15-16.

LANZA™

Finish Brushed Bronze
Glass Etched opal
Details Geometric patterned detailing; mounting hardware hidden on back plate



5421 BR



5100 BR



5104 BR INV



5103 BR INV



5102 BR INV



5105 BR INV

LANZA

Brushed Bronze (BR)

ITEM	WIDTH/DIA.	HEIGHT	EXT.	TOP TO OUTLET	BACK PLATE/CANOPY	BULBS	AVAILABLE FINISHES
5100 BR	7¼" W	12"	5"	6½"	4¾" W, 12" H Back Plate	1-60w G9*	AN, BR
5102 BR	16½" W	6¾"	5"	4"	9" W, 4¾" H Back Plate	2-60w G9*	AN, BR
5103 BR	25" W	6¾"	5"	4"	12" W, 4¾" H Back Plate	3-60w G9*	AN, BR
5104 BR	34" W	6¾"	5"	4"	12" W, 4¾" H Back Plate	4-60w G9*	AN, BR
5105 BR	43" W	6¾"	5"	4"	12" W, 4¾" H Back Plate	5-60w G9*	AN, BR
5421 BR**	17" Dia.	7"				3-60w Med.	BN, BR, OZ

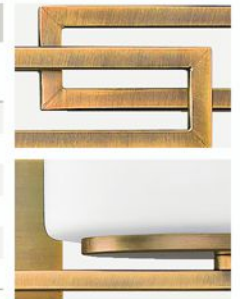

*G9 halogen bulbs included. **Recommended companion flush mount. For additional options, see pages 15-16.

DAPHNE™

Finish Chrome
Glass Pocket style bubble art
Details Raceway back plate; etched bottom lenses; ADA compliant



5922 CM 



5923 CM 



5920 CM 



5924 CM 



5925 CM 



DAPHNE

Chrome (CM)

ITEM	WIDTH/DIA.	HEIGHT	EXT.	TOP TO OUTLET	BACK PLATE/CANOPY	BULBS	AVAILABLE FINISHES
5920 CM	8½" W	9"	4"	4½"	8½" W, 9" H Back Plate	1-75w Med.	BN, BR, CM
5922 CM	16" W	5"	3¾"	2½"	16" W, 5" H Back Plate	2-60w G9*	BN, BR, CM
5923 CM	24" W	5"	3¾"	2½"	24" W, 5" H Back Plate	3-60w G9*	BN, BR, CM
5924 CM	32" W	5"	3¾"	2½"	32" W, 5" H Back Plate	4-60w G9*	BN, BR, CM
5925 CM	40" W	5"	3¾"	2½"	40" W, 5" H Back Plate	5-60w G9*	BN, BR, CM

*G9 halogen bulbs included. The Daphne family must be hung with socket facing upright. For flush mount options, see pages 15-16.

DAPHNE™

Finish Brushed Nickel
Glass Pocket style bubble art
Details Raceway back plate; etched bottom lenses; ADA compliant



5922 BN



5920 BN



5923 BN



5924 BN



5925 BN

DAPHNE		Brushed Nickel (BN)					
ITEM	WIDTH/DIA.	HEIGHT	EXT.	TOP TO OUTLET	BACK PLATE/CANOPY	BULBS	AVAILABLE FINISHES
5920 BN	8½" W	9"	4"	4½"	8½" W, 9" H Back Plate	1-75w Med.	BN, BR, CM
5922 BN	16" W	5"	3¾"	2½"	16" W, 5" H Back Plate	2-60w G9*	BN, BR, CM
5923 BN	24" W	5"	3¾"	2½"	24" W, 5" H Back Plate	3-60w G9*	BN, BR, CM
5924 BN	32" W	5"	3¾"	2½"	32" W, 5" H Back Plate	4-60w G9*	BN, BR, CM
5925 BN	40" W	5"	3¾"	2½"	40" W, 5" H Back Plate	5-60w G9*	BN, BR, CM



*G9 halogen bulbs included. The Daphne family must be hung with socket facing upright. For flush mount options, see pages 15-16.

DAPHNE™

Finish Brushed Bronze
Glass Amber pocket style bubble art
Details Raceway back plate;
 etched bottom lenses; ADA compliant



5922 BR



5923 BR

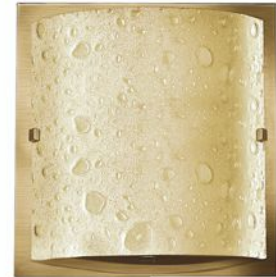

5920 BR



5924 BR



5925 BR



DAPHNE

Brushed Bronze (BR)

ITEM	WIDTH/DIA.	HEIGHT	EXT.	TOP TO OUTLET	BACK PLATE/CANOPY	BULBS	AVAILABLE FINISHES
5920 BR	8½" W	9"	4"	4½"	8½" W, 9" H Back Plate	1-75w Med.	BN, BR, CM
5922 BR	16" W	5"	3¾"	2½"	16" W, 5" H Back Plate	2-60w G9*	BN, BR, CM
5923 BR	24" W	5"	3¾"	2½"	24" W, 5" H Back Plate	3-60w G9*	BN, BR, CM
5924 BR	32" W	5"	3¾"	2½"	32" W, 5" H Back Plate	4-60w G9*	BN, BR, CM
5925 BR	40" W	5"	3¾"	2½"	40" W, 5" H Back Plate	5-60w G9*	BN, BR, CM

*G9 halogen bulbs included. The Daphne family must be hung with socket facing upright. For flush mount options, see pages 15-16.

MILEY™

Finish Chrome
Glass Cased opal
Details Cast stepped back plate; cast glass holders



5421 CM



5053 CM



5052 CM



5050 CM



5054 CM

MILEY

Chrome (CM)

ITEM	WIDTH/DIA.	HEIGHT	EXT.	TOP TO OUTLET	BACK PLATE/CANOPY	BULBS	AVAILABLE FINISHES
5050 CM	4½" W	6½"	5¼"	3¼"	4½" W, 6½" H Back Plate	1-60w G9*	BC, BN, CM
5052 CM	13" W	6"	5½"	3¾"	6½" W, 4½" H Back Plate	2-60w G9*	BC, BN, CM
5053 CM	21½" W	6"	5½"	3¾"	6½" W, 4½" H Back Plate	3-60w G9*	BC, BN, CM
5054 CM	30" W	6"	5½"	3¾"	6½" W, 4½" H Back Plate	4-60w G9*	BC, BN, CM
5421 CM**	17" Dia.	7"				3-60w Med.	BN, BR, CM, OZ

*G9 halogen bulbs included. **Recommended companion flush mount. For additional options, see pages 15-16.



MILEY™

Finish Brushed Nickel
Glass White etched
Details Cast stepped back plate;
 cast glass holders



5421 BN



5052 BN



5053 BN



5054 BN



5050 BN



MILEY

Brushed Nickel (BN)

ITEM	WIDTH/DIA.	HEIGHT	EXT.	TOP TO OUTLET	BACK PLATE/CANOPY	BULBS	AVAILABLE FINISHES
5050 BN	4½" W	6½"	5¼"	3¼"	4½" W, 6½" H Back Plate	1-60w G9*	BC, BN, CM
5052 BN	13" W	6"	5½"	3¾"	6½" W, 4½" H Back Plate	2-60w G9*	BC, BN, CM
5053 BN	21½" W	6"	5½"	3¾"	6½" W, 4½" H Back Plate	3-60w G9*	BC, BN, CM
5054 BN	30" W	6"	5½"	3¾"	6½" W, 4½" H Back Plate	4-60w G9*	BC, BN, CM
5421 BN**	17" Dia.	7"				3-60w Med.	BN, BR, CM, OZ

*G9 halogen bulbs included. **Recommended companion flush mount. For additional options, see pages 15-16.

MILEY™

Finish Brushed Caramel
Glass White etched
Details Cast stepped back plate; cast glass holders



5421 BR



5053 BC



5052 BC



5050 BC



5054 BC

MILEY

Brushed Caramel (BC)

ITEM	WIDTH/DIA.	HEIGHT	EXT.	TOP TO OUTLET	BACK PLATE/CANOPY	BULBS	AVAILABLE FINISHES
5050 BC	4½" W	6½"	5¼"	3¼"	4½" W, 6½" H Back Plate	1-60w G9*	BC, BN, CM
5052 BC	13" W	6"	5½"	3¾"	6½" W, 4½" H Back Plate	2-60w G9*	BC, BN, CM
5053 BC	21½" W	6"	5½"	3¾"	6½" W, 4½" H Back Plate	3-60w G9*	BC, BN, CM
5054 BC	30" W	6"	5½"	3¾"	6½" W, 4½" H Back Plate	4-60w G9*	BC, BN, CM
5421 BR**	17" Dia.	7"				3-60w Med.	BN, BR, CM, OZ

*G9 halogen bulbs included. **Recommended companion flush mount. For additional options, see pages 15-16.



ELEMENT™

Finish Brushed Nickel
Glass Etched opal
Details Tapered square back plate; soft square glass is open on top and bottom



5222 BN



5223 BN



5220 BN



5224 BN



ELEMENT

Brushed Nickel (BN)

ITEM	WIDTH/DIA.	HEIGHT	EXT.	TOP TO OUTLET	BACK PLATE/CANOPY	BULBS	AVAILABLE FINISHES
5220 BN	5¼" W	7"	5¾"	4¼"	5¼" W, 5¼" H Back Plate	1-60w G9*	BN
5222 BN	12¼" W	7"	5¾"	4¼"	5¼" W, 5¼" H Back Plate	2-60w G9*	BN
5223 BN	20½" W	7"	5¾"	4¼"	5¼" W, 5¼" H Back Plate	3-60w G9*	BN
5224 BN	28½" W	7"	5¾"	4¼"	5¼" W, 5¼" H Back Plate	4-60w G9*	BN

*G9 halogen bulbs included. For flush mount options, see pages 15-16.

BROOKE™

Finish Antique Nickel
Glass Etched opal
Details Hand-forged decorative detailing



4371 PL



5003 AN



5002 AN



5000 AN



5004 AN

BROOKE

Antique Nickel (AN)

ITEM	WIDTH/DIA.	HEIGHT	EXT.	TOP TO OUTLET	BACK PLATE/CANOPY	BULBS	AVAILABLE FINISHES
4371 PL*	15" Dia.	8½"				2-60w Med.	PL
5000 AN	5¼" W	11½"	5½"	8"	4½" W, 7" H Back Plate	1-100w Med.	AN
5002 AN	16½" W	10¼"	6"	6½"	9" W, 4½" H Back Plate	2-100w Med.	AN
5003 AN	24" W	10¾"	6"	7¼"	9" W, 4½" H Back Plate	3-100w Med.	AN
5004 AN	31¼" W	11"	6"	7"	9" W, 4½" H Back Plate	4-100w Med.	AN

*Recommended companion flush mount. For additional options, see pages 15-16.



OLIVIA™

Finish Antique Nickel or Brushed Bronze
Glass Etched opal
Details Hand-forged decorative detailing



5421 BN



5421 BR



5750 AN



5750 BR



5752 AN



5753 AN



5753 BR



5752 BR



OLIVIA

Antique Nickel (AN) or Brushed Bronze (BR)

ITEM	WIDTH/DIA.	HEIGHT	EXT.	TOP TO OUTLET	BACK PLATE/CANOPIY	BULBS	AVAILABLE FINISHES
5421 BN*	17" Dia.	7"				3-60w Med.	BN, BR, CM, OZ
5421 BR*	17" Dia.	7"				3-60w Med.	BN, BR, CM, OZ
5750 AN	5¼" W	8¼"	7¾"	4"	5" W, 8" H Back Plate	1-100w Med.	AN, BR
5750 BR	5¼" W	8¼"	7¾"	4"	5" W, 8" H Back Plate	1-100w Med.	AN, BR
5752 AN	15½" W	8¼"	8¼"	5"	8" W, 5" H Back Plate	2-100w Med.	AN, BR
5752 BR	15½" W	8¼"	8¼"	5"	8" W, 5" H Back Plate	2-100w Med.	AN, BR
5753 AN	23½" W	8¼"	10¼"	5"	8" W, 5" H Back Plate	3-100w Med.	AN, BR
5753 BR	23½" W	8¼"	10¼"	5"	8" W, 5" H Back Plate	3-100w Med.	AN, BR

*Recommended companion flush mount. For additional options, see pages 15-16.

BLOOM™



4371 PL

Finish Polished Antique Nickel
Glass Inside etched
Details Cast detailing
See also Bloom chandeliers, pages 50-51



5873 PL



5872 PL



5870 PL



5874 PL

BLOOM

Polished Antique Nickel (PL)

ITEM	WIDTH/DIA.	HEIGHT	EXT.	TOP TO OUTLET	BACK PLATE/CANOPY	BULBS	AVAILABLE FINISHES
4371 PL	15" Dia.	8½"				2-60w Med.	PL
5870 PL	6¾" W	9"	8"	4½"	5" W, 9" H Back Plate	1-100w Med.	PL
5872 PL	17½" W	8¾"	8"	6¼"	9" W, 5" H Back Plate	2-100w Med.	PL
5873 PL	25½" W	8¾"	8"	6¼"	9" W, 5" H Back Plate	3-100w Med.	PL
5874 PL	34¾" W	8¾"	8"	6¼"	9" W, 5" H Back Plate	4-100w Med.	PL



JOSIE™

- Finish** Brushed Nickel
- Glass** Etched opal
- Details** Raceway back plate; glass transitions from square to round; mounting hardware hidden on back plate



5551 BN



5370 BN INV



5372 BN INV



5373 BN INV



5375 BN INV



JOSIE

Brushed Nickel (BN)

ITEM	WIDTH/DIA.	HEIGHT	EXT.	TOP TO OUTLET	BACK PLATE/CANOPY	BULBS	AVAILABLE FINISHES
5370 BN	4½" W	8½"	6¼"	5"	4½" W, 7" H Back Plate	1-100w Med.	BN
5372 BN	15½" W	7¼"	6"	5"	7" W, 4½" H Back Plate	2-100w Med.	BN
5373 BN	23" W	8"	6"	5¾"	18" W, 4½" H Back Plate	3-100w Med.	BN
5375 BN	37½" W	8½"	6"	6¼"	18" W, 4½" H Back Plate	5-100w Med.	BN
5551 BN*	15" Dia.	7¾"				2-60w Med.	BN, CM

*Recommended companion flush mount. For additional options, see pages 15-16.

ADDISON™

Finish Polished Antique Nickel
Glass Etched opal
Details Cast detailing



4371 PL



5863 PL



5862 PL



5860 PL



5864 PL

ADDISON

Polished Antique Nickel (PL)

ITEM	WIDTH/DIA.	HEIGHT	EXT.	TOP TO OUTLET	BACK PLATE/CANOPY	BULBS	AVAILABLE FINISHES
4371 PL*	15" Dia.	8½"				2-60w Med.	PL
5860 PL	6½" W	7½"	9"	5"	5" Dia. Back Plate	1-100w Med.	PL
5862 PL	16½" W	7½"	8¼"	5"	5" Dia. Back Plate	2-100w Med.	PL
5863 PL	23¾" W	7½"	9"	5"	5" Dia. Back Plate	3-100w Med.	PL
5864 PL	32¼" W	7½"	9"	5"	5" Dia. Back Plate	4-100w Med.	PL

*Recommended companion flush mount. For additional options, see pages 15-16.



CARINA™

Finish Polished Antique Nickel
Glass Cased opal
Details Decorative glass trim rings; mounting hardware hidden on back plate



5431 PL



5432 PL INV



5433 PL INV



5434 PL INV



5430 PL INV



CARINA

Polished Antique Nickel (PL)

ITEM	WIDTH/DIA.	HEIGHT	EXT.	TOP TO OUTLET	BACK PLATE/CANOPY	BULBS	AVAILABLE FINISHES
5430 PL	5" W	9"	7"	4½"	5" W, 9" H Back Plate	1-100w Med.	PL
5431 PL	13¼" Dia.	12"			5" Dia. Canopy	3-75w Med.	PL
5432 PL	13½" W	8"	6¾"	¾"	9" W, 5" H Back Plate	2-100w Med.	PL
5433 PL	20¼" W	8"	6¾"	¾"	9" W, 5" H Back Plate	3-100w Med.	PL
5434 PL	27½" W	8"	6¾"	¾"	9" W, 5" H Back Plate	4-100w Med.	PL

ANNA™

Finish Chrome
Glass Etched opal
Details Mounting hardware hidden on back plate



5781 CM



5783 CM INV



5782 CM INV



5780 CM INV



5784 CM INV

ANNA		Chrome (CM)					
ITEM	WIDTH/DIA.	HEIGHT	EXT.	TOP TO OUTLET	BACK PLATE/CANOPY	BULBS	AVAILABLE FINISHES
5780 CM	6" W	8¾"	7¼"	6"	6" W, 5¼" H Back Plate	1-100w Med.	CM
5781 CM	17" Dia.	6½"				3-60w Med.	CM
5782 CM	14¾" W	8¾"	7¼"	6"	6" W, 5¼" H Back Plate	2-100w Med.	CM
5783 CM	24" W	8¾"	7¼"	6"	6" W, 5¼" H Back Plate	3-100w Med.	CM
5784 CM	33¾" W	8¾"	7¼"	6"	6" W, 5¼" H Back Plate	4-100w Med.	CM



BOLLA™

- Finish** Brushed Nickel
- Glass** Etched opal
- Details** Heavy cast ball transition detail
- See also** Bolla chandeliers, pages 72-81
Bolla outdoor, pages 300-303



4660 BN



4650 BN



5894 BN



5893 BN



5892 BN



5895 BN



BOLLA

Brushed Nickel (BN)

ITEM	WIDTH/DIA.	HEIGHT	EXT.	TOP TO OUTLET	BACK PLATE/CANOPY	BULBS	AVAILABLE FINISHES
4650 BN	7¾" W	8½"	8¾"	3½"	6" W, 7½" H Back Plate	1-100w Med.	BN, BR, OB
4660 BN	16¾" Dia.	8"			5" Dia. Canopy	2-75w Med.	BN, BR, OB
5892 BN	16" W	8¾"	6¾"	6½"	9¼" W, 4½" H Back Plate	2-100w Med.	BN, BR, OB
5893 BN	26" W	8¾"	6¾"	6½"	9¼" W, 4½" H Back Plate	3-100w Med.	BN, BR, OB
5894 BN	35¾" W	8¾"	6¾"	6½"	9¼" W, 4½" H Back Plate	4-100w Med.	BN, BR, OB
5895 BN	45¾" W	8¾"	6¾"	6½"	18¼" W, 4½" H Back Plate	5-100w Med.	BN, BR, OB

BOLLA™



4650 BR



4660 BR

Finish Brushed Bronze
Glass Light amber seedy
Details Heavy cast ball transition detail
See also Bolla chandeliers, pages 72-83
 Bolla outdoor, pages 300-303



5894 BR



5892 BR



5893 BR



5895 BR

BOLLA

Brushed Bronze (BR)

ITEM	WIDTH/DIA.	HEIGHT	EXT.	TOP TO OUTLET	BACK PLATE/CANOPY	BULBS	AVAILABLE FINISHES
4650 BR	7¾" W	8½"	8¾"	3½"	6" W, 7½" H Back Plate	1-100w Med.	BN, BR, OB
4660 BR	16¾" Dia.	8"			5" Dia. Canopy	2-75w Med.	BN, BR, OB
5892 BR	16" W	8¾"	6¾"	6½"	9¼" W, 4½" H Back Plate	2-100w Med.	BN, BR, OB
5893 BR	26" W	8¾"	6¾"	6½"	9¼" W, 4½" H Back Plate	3-100w Med.	BN, BR, OB
5894 BR	35¾" W	8¾"	6¾"	6½"	9¼" W, 4½" H Back Plate	4-100w Med.	BN, BR, OB
5895 BR	45¾" W	8¾"	6¾"	6½"	18¼" W, 4½" H Back Plate	5-100w Med.	BN, BR, OB



BOLLA™

Finish Olde Bronze
Glass Light amber seedy
Details Heavy cast ball transition detail
See also Bolla chandeliers, pages 72-83
 Bolla outdoor, pages 300-303



4660 OB



4650 OB



5894 OB



5893 OB



5892 OB



5895 OB



BOLLA

Olde Bronze (OB)

ITEM	WIDTH/DIA.	HEIGHT	EXT.	TOP TO OUTLET	BACK PLATE/CANOPY	BULBS	AVAILABLE FINISHES
4650 OB	7¾" W	8½"	8¾"	3½"	6" W, 7½" H Back Plate	1-100w Med.	BN, BR, OB
4660 OB	16¾" Dia.	8"			5" Dia. Canopy	2-75w Med.	BN, BR, OB
5892 OB	16" W	8¾"	6¾"	6½"	9¼" W, 4½" H Back Plate	2-100w Med.	BN, BR, OB
5893 OB	26" W	8¾"	6¾"	6½"	9¼" W, 4½" H Back Plate	3-100w Med.	BN, BR, OB
5894 OB	35¾" W	8¾"	6¾"	6½"	9¼" W, 4½" H Back Plate	4-100w Med.	BN, BR, OB
5895 OB	45¾" W	8¾"	6¾"	6½"	18¼" W, 4½" H Back Plate	5-100w Med.	BN, BR, OB

PLYMOUTH™



4241 OB

Finish Olde Bronze
Glass Mocha-colored
Details Finish features subtle hand rubbed highlights; cast stepped back plate; cast detailing

See also Plymouth chandeliers, pages 114-115



5473 OB



5472 OB



5470 OB



5474 OB

PLYMOUTH

Olde Bronze (OB)

ITEM	WIDTH/DIA.	HEIGHT	EXT.	TOP TO OUTLET	BACK PLATE/CANOPY	BULBS	AVAILABLE FINISHES
4241 OB	17½" Dia.	8¼"				3-60w Med.	OB
5470 OB	5½" W	9½"	7¾"	4¾"	4½" W, 9¼" H Back Plate	1-100w Med.	OB
5472 OB	13½" W	8"	7¾"	4¼"	9¼" W, 4¼" H Back Plate	2-100w Med.	OB
5473 OB	21½" W	8"	7¾"	4¼"	9¼" W, 4¼" H Back Plate	3-100w Med.	OB
5474 OB	29½" W	8"	7¾"	4¼"	9¼" W, 4¼" H Back Plate	4-100w Med.	OB



PORTOFINO™

- Finish** Victorian Bronze
- Glass** Champagne marble
- Details** Hand-forged solid iron elements; hand-wrapped vine details
- See also** Portofino chandeliers, pages 112-113



4111 VZ



5562 VZ



5563 VZ



5564 VZ



5560 VZ



PORTOFINO

Victorian Bronze (VZ)

ITEM	WIDTH/DIA.	HEIGHT	EXT.	TOP TO OUTLET	BACK PLATE/CANOPY	BULBS	AVAILABLE FINISHES
4111 VZ	18" Dia.	13¾"			5½" Dia. Canopy	3-75w Med.	VZ
5560 VZ	5" W	12"	8"	7½"	5" W, 9" H Back Plate	1-100w Med.	VZ
5562 VZ	14¾" W	10"	6½"	6¾"	9" W, 5" H Back Plate	2-100w Med.	VZ
5563 VZ	24" W	10"	6½"	6¾"	9" W, 5" H Back Plate	3-100w Med.	VZ
5564 VZ	30" W	10"	6½"	6¾"	9" W, 5" H Back Plate	4-100w Med.	VZ

STOWE™

Finish Metro Copper
Glass Antique light scavo
Details Hand-forged iron work; finish has subtle red copper hues
See also Stowe chandeliers, pages 98-99



4721 MC



5733 MC



5732 MC



4720 MC



5734 MC

STOWE

Metro Copper (MC)

ITEM	WIDTH/DIA.	HEIGHT	EXT.	TOP TO OUTLET	BACK PLATE/CANOPY	BULBS	AVAILABLE FINISHES
4720 MC	5" W	14"	6½"	6¾"	4¼" W, 7" H Back Plate	1-100w Med.	MC
4721 MC	15½" Dia.	6¾"				2-75w Med.	MC
5732 MC	11¾" W	8"	6½"	4¼"	8" W, 4¼" H Back Plate	2-100w Med.	MC
5733 MC	19¾" W	8"	6½"	4¼"	8" W, 4¼" H Back Plate	3-100w Med.	MC
5734 MC	27½" W	8"	6½"	4¼"	8" W, 4¼" H Back Plate	4-100w Med.	MC



THISTLEDOWN™

Finish Victorian Bronze
Glass Amber linen
Details Yoke-mount detailing
See also Thistledown chandeliers, pages 100-102
 Thistledown outdoor, pages 316-317



4171 VZ  



5682 VZ



5683 VZ



5684 VZ



5680 VZ



THISTLEDOWN

Victorian Bronze (VZ)

ITEM	WIDTH/DIA.	HEIGHT	EXT.	TOP TO OUTLET	BACK PLATE/CANOPY	BULBS	AVAILABLE FINISHES
4171 VZ	15¼" Dia.	8"				3-60w Med.	VZ
5680 VZ	5¾" W	12¼"	7¾"	9½"	5¾" Dia. Back Plate	1-100w Med.	VZ
5682 VZ	13½" W	12¼"	7¾"	9½"	5¾" Dia. Back Plate	2-100w Med.	VZ
5683 VZ	21¾" W	12¼"	7¾"	9½"	5¾" Dia. Back Plate	3-100w Med.	VZ
5684 VZ	30" W	12¼"	7¾"	9½"	5¾" Dia. Back Plate	4-100w Med.	VZ

CASA™

Finish Olde Black
Glass Antique scavo
Details Individually unique shaped glass; square shaped wrought iron features hand-forged twisted scroll work
See also Casa chandeliers, pages 126-129
 Casa outdoor, pages 314-315



3501 OL



5544 OL



5543 OL



5542 OL



4010 OL



5545 OL



CASA

Olde Black (OL)

ITEM	WIDTH/DIA.	HEIGHT	EXT.	TOP TO OUTLET	BACK PLATE/CANOPY	BULBS	AVAILABLE FINISHES
3501 OL	14¼" Dia.	8¾"				3-60w Med.	OL
4010 OL	5" W	10¾"	6"	6¾"	5" W, 7¾" H Back Plate	1-100w Med.	OL
5542 OL	15¾" W	8¾"	7"	3¼"	7½" W, 5" H Back Plate	2-100w Med.	OL
5543 OL	22¾" W	8¾"	7"	3¼"	7½" W, 5" H Back Plate	3-100w Med.	OL
5544 OL	29½" W	8¾"	7"	3¼"	7½" W, 5" H Back Plate	4-100w Med.	OL
5545 OL	35¾" W	8¾"	7"	3¼"	7½" W, 5" H Back Plate	5-100w Med.	OL



FLYNN™

- Finish** Blacksmith
- Glass** Marbled amber
- Details** Low profile glass; bracket and pin mounting detailing



5822 BH



5823 BH



5820 BH



5824 BH



FLYNN

Blacksmith (BH)

ITEM	WIDTH/DIA.	HEIGHT	EXT.	TOP TO OUTLET	BACK PLATE/CANOPY	BULBS	AVAILABLE FINISHES
5820 BH	7¾" W	4½"	5¼"	2¼"	7¾" W, 4½" Back Plate	1-60w G9*	BH
5822 BH	17" W	4½"	5¼"	2¼"	7¾" W, 4½" Back Plate	2-60w G9*	BH
5823 BH	26" W	4½"	5¼"	2¼"	7¾" W, 4½" Back Plate	3-60w G9*	BH
5824 BH	35¼" W	4½"	5¼"	2¼"	7¾" W, 4½" Back Plate	4-60w G9*	BH

*G9 halogen bulbs included. For flush mount options, see pages 15-16.

ISABELLA™

Finish Polished Antique Nickel
Glass Marbled etched amber
Details Decorative cast detailing



5391 PL



5392 PL



5393 PL



5390 PL



5394 PL

ISABELLA

Polished Antique Nickel (PL)

ITEM	WIDTH/DIA.	HEIGHT	EXT.	TOP TO OUTLET	BACK PLATE/CANOPY	BULBS	AVAILABLE FINISHES
5390 PL	5½" W	10"	8"	5¼"	5½" W, 9¼" H Back Plate	1-100w Med.	BB, PL
5391 PL	15" Dia.	9¾"			5" Dia. Canopy	3-60w Med.	BB, PL
5392 PL	16¾" W	9¼"	8"	5¼"	16¼" W, 5½" H Back Plate	2-100w Med.	BB, PL
5393 PL	21¼" W	9¼"	8"	5¼"	16¼" W, 5½" H Back Plate	3-100w Med.	BB, PL
5394 PL	29" W	9¼"	8"	5¼"	16¼" W, 5½" H Back Plate	4-100w Med.	BB, PL



ISABELLA™

Finish Burnished Brass
Glass Marbled etched amber
Details Decorative cast detailing



5391 BB



5393 BB



5392 BB



5394 BB



5390 BB



ISABELLA

Burnished Brass (BB)

ITEM	WIDTH/DIA.	HEIGHT	EXT.	TOP TO OUTLET	BACK PLATE/CANOPY	BULBS	AVAILABLE FINISHES
5390 BB	5½" W	10"	8"	5¼"	5½" W, 9¼" H Back Plate	1-100w Med.	BB, PL
5391 BB	15" Dia.	9¾"			5" Dia. Canopy	3-60w Med.	BB, PL
5392 BB	16¾" W	9¼"	8"	5¼"	16¼" W, 5½" H Back Plate	2-100w Med.	BB, PL
5393 BB	21¼" W	9¼"	8"	5¼"	16¼" W, 5½" H Back Plate	3-100w Med.	BB, PL
5394 BB	29" W	9¼"	8"	5¼"	16¼" W, 5½" H Back Plate	4-100w Med.	BB, PL

FRANCOISE™

Finish Burnished Brass
Glass Frosted ribbed
Details Decorative cast detailing



5583 BB



5582 BB



5584 BB



5580 BB



5585 BB

FRANCOISE

Burnished Brass (BB)

ITEM	WIDTH/DIA.	HEIGHT	EXT.	TOP TO OUTLET	BACK PLATE/CANOPY	BULBS	AVAILABLE FINISHES
5580 BB	6" W	10¾"	6¾"	6¼"	4½" W, 9¼" H Back Plate	1-100w Med.	BB, PL
5582 BB	15" W	9½"	6¾"	7¼"	9¼" W, 4½" H Back Plate	2-100w Med.	BB, PL
5583 BB	25½" W	9½"	6¾"	7¼"	9¼" W, 4½" H Back Plate	3-100w Med.	BB, PL
5584 BB	30½" W	9½"	6¾"	7¼"	9¼" W, 4½" H Back Plate	4-100w Med.	BB, PL
5585 BB	37" W	9½"	6¾"	7¼"	9¼" W, 4½" H Back Plate	5-100w Med.	BB, PL

For flush mount options, see pages 15-16.



FRANCOISE™

Finish Polished Antique Nickel
Glass Frosted ribbed
Details Decorative cast detailing



5583 PL



5584 PL



5582 PL



5585 PL



5580 PL



FRANCOISE

Polished Antique Nickel (PL)

ITEM	WIDTH/DIA.	HEIGHT	EXT.	TOP TO OUTLET	BACK PLATE/CANOPY	BULBS	AVAILABLE FINISHES
5580 PL	6" W	10¾"	6¾"	6¼"	4½" W, 9¼" H Back Plate	1-100w Med.	BB, PL
5582 PL	15" W	9½"	6¾"	7¼"	9¼" W, 4½" H Back Plate	2-100w Med.	BB, PL
5583 PL	25¼" W	9½"	6¾"	7¼"	9¼" W, 4½" H Back Plate	3-100w Med.	BB, PL
5584 PL	30½" W	9½"	6¾"	7¼"	9¼" W, 4½" H Back Plate	4-100w Med.	BB, PL
5585 PL	37" W	9½"	6¾"	7¼"	9¼" W, 4½" H Back Plate	5-100w Med.	BB, PL

For flush mount options, see pages 15-16.

PLANTATION™

Finish Burnished Brass
Glass Clear optic
Details Decorative cast detailing
See also Plantation chandeliers, pages 138-147
 Plantation outdoor, pages 382-387



4102 BB



4881 BB



5313 BB



5312 BB



5310 BB



5314 BB

PLANTATION

Burnished Brass (BB)

ITEM	WIDTH/DIA.	HEIGHT	EXT.	TOP TO OUTLET	BACK PLATE/CANOPY	BULBS	AVAILABLE FINISHES
4102 BB	12" Dia.	8"				2-60w Med.	BB, CB, PL, PZ
4881 BB	16" Dia.	8¾"				3-60w Med.	BB, CB, PL, PZ
5310 BB	5" W	8¾"	6½"	5"	4¾" W, 8" H Back Plate	1-100w Med.	BB, PL, PZ
5312 BB	13" W	8¾"	6¾"	4¾"	8" W, 4¾" H Back Plate	2-100w Med.	BB, PL
5313 BB	21" W	8¾"	6¾"	4¾"	8" W, 4¾" H Back Plate	3-100w Med.	BB, PL
5314 BB	29" W	8¾"	6¾"	4¾"	8" W, 4¾" H Back Plate	4-100w Med.	BB, PL



PLANTATION™

Finish Polished Antique Nickel
Glass Clear optic
Details Decorative cast detailing
See also Plantation chandeliers, pages 138-147
 Plantation outdoor, pages 382-387



4881 PL



4102 PL



5312 PL



5313 PL



5314 PL



5310 PL



PLANTATION

Polished Antique Nickel (PL)

ITEM	WIDTH/DIA.	HEIGHT	EXT.	TOP TO OUTLET	BACK PLATE/CANOPY	BULBS	AVAILABLE FINISHES
4102 PL	12" Dia.	8"				2-60w Med.	BB, CB, PL, PZ
4881 PL	16" Dia.	8¾"				3-60w Med.	BB, CB, PL, PZ
5310 PL	5" W	8¾"	6½"	5"	4¾" W, 8" H Back Plate	1-100w Med.	BB, PL, PZ
5312 PL	13" W	8¾"	6¾"	4¾"	8" W, 4¾" H Back Plate	2-100w Med.	BB, PL
5313 PL	21" W	8¾"	6¾"	4¾"	8" W, 4¾" H Back Plate	3-100w Med.	BB, PL
5314 PL	29" W	8¾"	6¾"	4¾"	8" W, 4¾" H Back Plate	4-100w Med.	BB, PL

OUTDOOR

HIGHLIGHT THE NIGHT



“Simply put,
outdoor lighting
creates enchantment.”

- AMY ELBERT

Atlantis	266-273	Ellis	264-265	Oxford	344-345	Thistledown	316-317
Augusta	352-353	Elm	310-311	Parkside	338-339	Titan	282-283
Aurora	318-319	Forum	392-393	Pearl	394	Trafalgar	332-333
Bolla	300-303	Freeport	370-373	Plantation	382-387	Trellis	346-347
Brynmor	376-377	Hanna	308	Raley	396-397	Wabash	334-335
Buckley	328-329	Harbor	296-299	Reef	294-295	Wellington	374-375
Camelot	402-403	Innsbruck	342-343	Regal	404-405	Westwinds	364-365
Cape Cod	368-369	Key West	306-307	Revere	362-363	Windsor	390-391
Casa	314-315	Kube	278-281	Rowe Park	378-379		
Cascade	284-285	Ledgewood	320-323	San Clemente	354-357	Posts & Pier	
Castelle	324-327	Lucerne	348-349	San Mateo	304-305	Mounts	406-407
Cherry Creek	336-337	Luna	274-277	Saturn	260-263		
Clifton Beach	358-359	Manor House	398-399	Senator	395	Hinkley	
Clifton Park	360-361	Monticello	350-351	Sierra	286-287	Landscape	408-413
Cordillera	312-313	Montreal	380-381	Sorrento	388-389	Lighting	
Dwell	288-293	Nantucket	366-367	Stratford	330-331		
Edgewater	400-401	Oak Park	309	Tahoe	340-341		

welcome HOME

"Illuminating a deck, patio, or other outdoor dining and sitting area allows you to use those spaces in the evening hours, and enjoy the sounds, fragrances and fresh air of the outdoors. Outdoor lighting encourages people to step outside and creates a wonderful indoor-outdoor connection beyond daylight hours."

– Amy Elbert

OUTDOOR LIGHTING ENHANCES THE BEAUTY OF YOUR PROPERTY, MAKES YOUR HOME SAFER AND MORE SECURE AND INCREASES THE NUMBER OF PLEASURABLE HOURS YOU SPEND OUTDOORS.

A well-lit front entrance enables you to greet guests and identify visitors. Wall lanterns on each side of the door will give your home a warm, welcoming look while ensuring the safety of those who enter. Under a porch or other overhang you can feature chain-hung lanterns or flush mounts. A separate rear or side entrance can be illuminated with a single wall lantern installed on the keyhole side of the door.

STYLE TIP : Coordinate the style of your outdoor lighting with the style of your home's exterior. Creating a unified look on the outside makes a sharp first impression, and leaves room for variety on the inside.





enchanted EVENING

Lighting is one of the easiest and least expensive ways to cast an enchanting spell on any outdoor space. Properly placed lighting can define an outdoor patio or backyard hideaway while adding stylish charm. An added benefit is being able to enjoy your home's landscaping from inside, creating a cohesive space both inside and out.

"Simply put, outdoor lighting creates enchantment. Lighting can create garden focal points, defining areas of interest. It's wonderful to highlight garden features, such as arbors, birdbaths or water features. Many gardeners enjoy planting white or "moon" gardens that glow at night, with the help of subtle lighting. Outdoor lighting is a wonderful way to define intimate sitting and dining areas that are particularly conducive to relaxation and conversation. Large bushes and shrubs can present interesting textures and outlines when they are highlighted or you can create dramatic pools of light near plants or shrubs.

In addition, lighting is an effective way to showcase architectural elements of your home, such as archways, porches or brackets. Swimming pools offer a fabulous opportunity with outdoor lighting. Lights on water create magical, shimmering effects."

– Amy Elbert

Fixture shown on page 251: Freeport 1802 OZ, page 373

Fixtures shown on page 252: Revere 1184 SN, page 363;
Nexus 15405 BZ and 15402 BZ page 413

Fixtures shown above: Atlantis 1648 TT, page 268



“Lighting is becoming more and more important outdoors as we extend our spaces to create “rooms” outside.”

– Kyle Schuneman

OUTDOOR LIVING *today*

The desire for outdoor living spaces continues to thrive as homeowners are spending more time at home both indoors and out. Creating a charming and comfortable outdoor space allows you to enjoy the beauty of nature well into the evening. The continual evolution of outdoor lighting, furniture and accessories make the creation of these outdoor havens more practical and more stylish than ever before.

"I think as we get busier and busier, creating a space that combines nature with modern function is of the utmost importance."

– Carrie Fundingsland



OUTDOORS *inside*

Don't be afraid to place outdoor lanterns in your home's interior. Current outdoor lighting designs span the gamut from traditional lanterns to sleek pocket style sconces, which "opens the door" for getting creative with your decor. Choosing outdoor lanterns for an interior setting can add a distinct element of style if it works with the overall aesthetic of the home.

"I think using old-style barn sconces above bedside tables is a great way to free up the space on your nightstand and create a quirky fun design element."

– Kyle Schuneman

GOING GREEN

Today, we know how important it is to take care of our planet. As homeowners we now have options that can help in this effort, including energy efficient lighting. Hinkley offers a variety of options that allow you to design a lighting plan with the environment in mind:



ENERGY SAVING (ES)

Fixtures come equipped with GU24 sockets and include self-ballasted, CFL bulbs. Fixtures meet California's Title 24 requirements.



DARK SKY (DS)

Fixtures come equipped with a captive reflector or other design feature that minimizes or eliminates light glare upward into the night sky.



ENERGY SAVING DARK SKY (ESDS)

Fixtures come equipped with the combined technology of Energy Saving (ES) and Dark Sky (DS) configurations. Fixtures meet California's Title 24 requirements.



ENERGY STAR (EST)

Fixtures meet strict energy efficient guidelines set by the EPA and the DOE. Fixtures combine a GU24 socket together with a self-ballasted CFL bulb and a photocell.



LED

Fixtures come equipped with a fully integrated LED light source and built-in driver.



PHOTOCELL

Fixtures come equipped with a photocell that prevents the fixture from staying illuminated during daylight hours.



Fixtures shown above: Dwell 1325 BK, page 288
 Fixtures shown on page 257: Luna 1664 TT, page 274



66"

1 LANTERN
1/3 the height of the door

2 LANTERNS
1/4 the height of the door

HOW TO SIZE *an outdoor lantern*

Selecting the right-sized outdoor lantern can sometimes pose a challenge. Follow these sizing guidelines for a fit that's just right.

The height of an outdoor lantern should be based on the height of the door:

DON'T UNDERSIZE YOUR LANTERNS: As a rule of thumb, your lanterns should appear to be about half the size of your door from 50' away.

FOR 1 LANTERN: If you place a lantern on only one side of the door, it should measure one-third the height of the door. The center of the bulb should rest 66" above the threshold of the door.

FOR 2 LANTERNS: When two lanterns are used, they should each measure approximately one-fourth the height of the door. The center of the bulb should rest 66" above the threshold of the door.

TIP: In either case, if you choose a fixture with a long tail or top scroll, pay attention to the overall bulk of the fixture.

TIP: When in doubt, always go larger.

A photograph of a garden with a stone house, a wooden pergola, and several lit landscape lamps. The scene is lush with greenery, including trees and bushes. The house has a white window and a stone facade. The pergola is made of dark wood. The lamps are small, square, and lit, casting a warm glow. The overall atmosphere is serene and well-maintained.

HINKLEY *landscape lighting*

Hinkley provides a collection of decorative and functional landscape lighting that will help you complete your home's lighting plan. To view our full line of landscape lighting, including solid brass and LED landscape options, visit us online or see our full-line Hinkley Landscape Lighting catalog. www.hinkleylandscapelighting.com

"Consider the architecture of your home when you're choosing landscape light fixtures, so the style is appropriate to the period, scale and design of your home. It's often nice to repeat a motif, material, or color in the house to blend the structure with the outdoor fixtures. In most cases, you want the light to highlight a feature in your garden, not draw attention to itself. For that reason, fixtures made with natural materials, nature inspired colors, and organic shapes are particularly well suited. When choosing a fixture, consider too how it will look when exposed during the winter months when there is little plant growth."

— Amy Elbert

NIGHT *aglow*

It is important to consider all aspects of your home's property when developing your lighting plan, including the landscaping. Landscape lighting works with your other outdoor lighting to reveal your home and the surrounding grounds with a warm glow after the sun goes down. You will want to remember to conceal the light source behind shrubs and trees when possible – except when the fixture itself is a decorative element – to be sure the focus is on the landscaping and natural surroundings.

warm GLOW

Dimmer controls aren't just for chandeliers and other interior lighting. Fitting your outdoor fixtures with dimmer controls will give you the flexibility to design a lighting plan with multiple uses and decorative effects.



SAFETY *first*

The proper outdoor lighting plan not only adds beauty and value to your home, but it also is the first precaution in ensuring safety and security for you and your guests. It is important to illuminate paths, walkways, driveways, around decks, patios and stairs to create an easy-to-navigate landscape while protecting against unwanted guests.

"The initial importance of outdoor lighting is for security and safety. How many times have you gone to a new home at night for a party and you can't see the address or you are tripping over planters, etc. because the outside is not lit properly? What about being inside and making sure that you can see your own property well enough to see incoming visitors, either welcomed or not? The secondary factors are aesthetic."

– Lisa Rachele McDenon

SATURN™

Finish Stainless Steel
Glass Etched opal
Details #304 stainless steel construction
See also Saturn landscape, page 409



1909 SS
(pocket wall mount)





1902 SS



1905 SS



1908 SS  (pocket wall mount)



1900 SS







1904 SS



1901 SS

SATURN

Stainless Steel (SS)

ITEM	WIDTH/DIA.	HEIGHT	EXT.	TOP TO OUTLET	BACK PLATE/CANOPY	WIRE/CHAIN	BULBS	AVAILABLE FINISHES					
1900 SS	6" W	12"	7½"	7½"	4¾" W, 9" H Back Plate		1-60w Med.	MT, SS	•				•
1901 SS	10" Dia.	21¾"			3" Dia. Post Fitter		1-100w Med.	MT, SS	•				•
1902 SS	10" Dia.	21¼"			5" Dia. Canopy	6', 5'	1-100w Med.	MT, SS	•				•
1904 SS	8" W	16"	9½"	9"	4¾" W, 12" H Back Plate		1-75w Med.	MT, SS	•				•
1905 SS	10" W	20¼"	11½"	12¼"	4¾" W, 14" H Back Plate		1-100w Med.	MT, SS	•				•
1908 SS	7¼" W	12½"	4"	6¼"	5¾" W, 12" H Back Plate		2-40w Cand.	MT, SS	•				• •
1909 SS	8" W	20½"	4¼"	10¼"	5" W, 20" H Back Plate		2-75w Med.	MT, SS	•				•

For posts and pier mounts, see pages 406-407.

AVAILABLE OPTIONS

SATURN™

Finish Metro Bronze
Glass Etched opal
Details Solid brass construction
See also Saturn landscape,
page 409



1909 MT
(pocket wall mount)





1902 MT



1905 MT



1908 MT 
(pocket wall mount)



1900 MT



1904 MT



1901 MT

SATURN Metro Bronze (MT)

ITEM	WIDTH/DIA.	HEIGHT	EXT.	TOP TO OUTLET	BACK PLATE/CANOPY	WIRE/CHAIN	BULBS	AVAILABLE FINISHES					
1900 MT	6" W	12"	7½"	7½"	4¾" W, 9" H Back Plate		1-60w Med.	MT, SS	•				•
1901 MT	10" Dia.	21¾"			3" Dia. Post Fitter		1-100w Med.	MT, SS	•				•
1902 MT	10" Dia.	21¼"			5" Dia. Canopy	6', 5'	1-100w Med.	MT, SS	•				•
1904 MT	8" W	16"	9½"	9"	4¾" W, 12" H Back Plate		1-75w Med.	MT, SS	•				•
1905 MT	10" W	20¼"	11½"	12¼"	4¾" W, 14" H Back Plate		1-100w Med.	MT, SS	•				•
1908 MT	7¼" W	12½"	4"	6¼"	5¾" W, 12" H Back Plate		2-40w Cand.	MT, SS	•				• •
1909 MT	8" W	20½"	4¼"	10¼"	5" W, 20" H Back Plate		2-75w Med.	MT, SS	•				•

For posts and pier mounts, see pages 406-407.

AVAILABLE OPTIONS

ELLIS™

- Finish** Black, Buckeye Bronze, Stainless Steel
Glass Etched opal
Details Stainless steel construction (2140 SS and 2144 SS only); floating back plate; glass has closed top



2140 SS

2144 SS





2140 BK

2144 BK

2140 KZ

2144 KZ

ELLIS

Black (BK), Buckeye Bronze (KZ) and Stainless Steel (SS)

ITEM	WIDTH/DIA.	HEIGHT	EXT.	TOP TO OUTLET	BACK PLATE/CANOPY	WIRE/CHAIN	BULBS	AVAILABLE FINISHES	    
2140 BK	5½" W	23"	5¾"	10¼"	4½" W, 7" H Back Plate		1-100w Med.	BK, KZ, SS	•
2140 KZ	5½" W	23"	5¾"	10¼"	4½" W, 7" H Back Plate		1-100w Med.	BK, KZ, SS	•
2140 SS	5½" W	23"	5¾"	10¼"	4½" W, 7" H Back Plate		1-100w Med.	BK, KZ, SS	•
2144 BK	5½" W	27½"	6¾"	12½"	4½" W, 7" H Back Plate		1-100w Med.	BK, KZ, SS	•
2144 KZ	5½" W	27½"	6¾"	12½"	4½" W, 7" H Back Plate		1-100w Med.	BK, KZ, SS	•
2144 SS	5½" W	27½"	6¾"	12½"	4½" W, 7" H Back Plate		1-100w Med.	BK, KZ, SS	•

AVAILABLE OPTIONS

ATLANTIS™

- Finish Bronze
- Glass Etched glass lenses; etched opal (1650 BZ and 1655 BZ only)
- Details Solid aluminum construction; dual light source options
- See also Atlantis landscape, page 409



1650 BZ 



1655 BZ



1648 BZ 



1649 BZ 

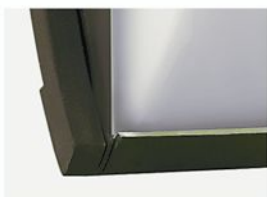

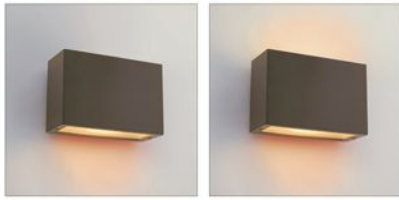

1646 BZ (left), 1646 SK, 1646 SW and 1646 TT will cast light down

1645 BZ (right), 1645 SK, 1645 SW and 1645 TT will cast light up and down



1646 BZ 
(pocket down light)



1645 BZ 
(pocket up/down light)



1640 BZ



1644 BZ

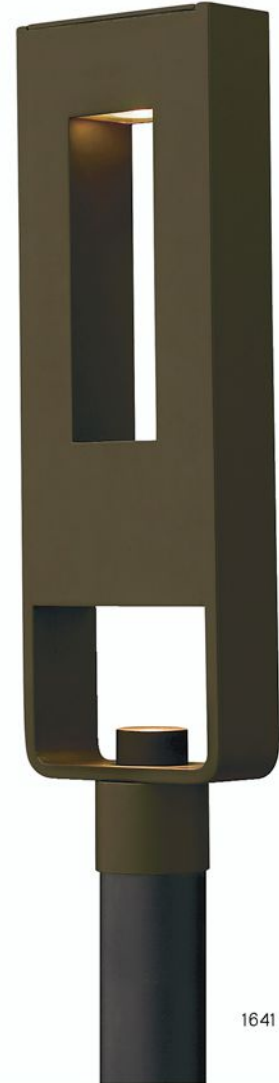

1641 BZ

ATLANTIS

Bronze (BZ)

ITEM	WIDTH/DIA.	HEIGHT	EXT.	DEPTH	TOP TO OUTLET	BACK PLATE/CANOPY	BULBS	AVAILABLE FINISHES					
1640 BZ	2¾" W	16"	6¾"		8"	4½" W, 4½" H Back Plate	2-12 volt, 20w MR-16**	BZ, SK, SW, TT	*				
1641 BZ	6¾" W	23½"		2¾"		3" Dia. Post Fitter	2-12 volt, 20w MR-16**	BZ, SK, SW, TT	*				
1644 BZ	3" W	24"	7"		12"	4½" W, 4½" H Back Plate	2-12 volt, 20w MR-16**	BZ, SK, SW, TT	*				
1645 BZ	9" W	5½"	4"		2¾"	4½" W, 4½" H Back Plate	1-75w Med.	BZ, SK, SW, TT	•				
1646 BZ	9" W	5½"	4"		2¾"	4½" W, 4½" H Back Plate	1-75w Med.	BZ, SK, SW, TT	•	*	•		
1648 BZ	6" W	16"	3½"		13¾"	4½" W, 4½" H Back Plate	2-12 volt, 20w MR-16**	BZ, SK, SW, TT	*				
1649 BZ	9" W	24"	4"		20¾"	4½" W, 6½" H Back Plate	2-12 volt, 20w MR-16**	BZ, SK, SW, TT	*				
1650 BZ	6¼" W	10½"	4"		5½"	5½" W, 5½" H Back Plate	1-60w Med.	BZ, TT	•		•	•	
1655 BZ	9" W	15¼"	5¾"		7¾"	5½" W, 8" H Back Plate	1-100w Med.	BZ, TT	•		•	•	

*Fixture comes standard Dark Sky compliant. **MR-16 Xenon bulbs included. For posts and pier mounts, see pages 406-407.

AVAILABLE OPTIONS

ATLANTIS™

- Finish** Titanium
- Glass** Etched glass lenses; etched opal (1650 TT and 1655 TT only)
- Details** Solid aluminum construction; dual light source options
- See also** Atlantis landscape, page 409



1650 TT 



1655 TT



1648 TT 



1649 TT 



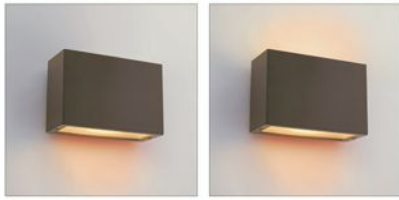

1646 BZ (left), 1646 SK, 1646 SW and 1646 TT will cast light down

1645 BZ (right), 1645 SK, 1645 SW and 1645 TT will cast light up and down



1646 TT (pocket down light)



1645 TT (pocket up/down light)



1640 TT



1644 TT



1641 TT

ATLANTIS

Titanium (TT)

ITEM	WIDTH/DIA.	HEIGHT	EXT.	DEPTH	TOP TO OUTLET	BACK PLATE/CANOPY	BULBS	AVAILABLE FINISHES					
1640 TT	2¾" W	16"	6¾"		8"	4½" W, 4½" H Back Plate	2-12 volt, 20w MR-16**	BZ, SK, SW, TT	*				•
1641 TT	6¾" W	23½"		2¾"		3" Dia. Post Fitter	2-12 volt, 20w MR-16**	BZ, SK, SW, TT	*				•
1644 TT	3" W	24"	7"		12"	4½" W, 4½" H Back Plate	2-12 volt, 20w MR-16**	BZ, SK, SW, TT	*				•
1645 TT	9" W	5½"	4"		2¾"	4½" W, 4½" H Back Plate	1-75w Med.	BZ, SK, SW, TT	•				•
1646 TT	9" W	5½"	4"		2¾"	4½" W, 4½" H Back Plate	1-75w Med.	BZ, SK, SW, TT	•	*	•		•
1648 TT	6" W	16"	3½"		13¾"	4½" W, 4½" H Back Plate	2-12 volt, 20w MR-16**	BZ, SK, SW, TT	*				•
1649 TT	9" W	24"	4"		20¾"	4½" W, 6½" H Back Plate	2-12 volt, 20w MR-16**	BZ, SK, SW, TT	*				•
1650 TT	8¼" W	10½"	4"		5¼"	5½" W, 5½" H Back Plate	1-60w Med.	BZ, TT	•			•	•
1655 TT	9" W	15¼"	5¾"		7¾"	5½" W, 8" H Back Plate	1-100w Med.	BZ, TT	•			•	•

*Fixture comes standard Dark Sky compliant. **MR-16 Xenon bulbs included. For posts and pier mounts, see pages 406-407.

AVAILABLE OPTIONS

ATLANTIS™

- Finish** Satin White
Glass Etched glass lenses
Details Solid aluminum construction;
dual light source options
See also Atlantis landscape, page 409



1649 SW 

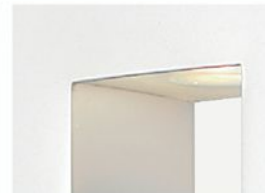

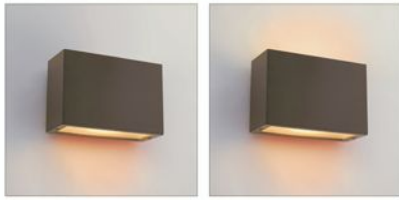

1646 BZ (left), 1646 SK, 1646 SW and 1646 TT will cast light down
 1645 BZ (right), 1645 SK, 1645 SW and 1645 TT will cast light up and down



1646 SW 
 (pocket down light)



1645 SW 
 (pocket up/down light)



1648 SW 



1640 SW







1644 SW



1641 SW

ATLANTIS

Satin White (SW)

ITEM	WIDTH/DIA.	HEIGHT	EXT.	DEPTH	TOP TO OUTLET	BACK PLATE/CANOPY	BULBS	AVAILABLE FINISHES					
1640 SW	2¾" W	16"	6¾"		8"	4½" W, 4½" H Back Plate	2-12 volt, 20w MR-16**	BZ, SK, SW, TT	*				•
1641 SW	6¾" W	23½"		2¾"		3" Dia. Post Fitter	2-12 volt, 20w MR-16**	BZ, SK, SW, TT	*				•
1644 SW	3" W	24"	7"		12"	4½" W, 4½" H Back Plate	2-12 volt, 20w MR-16**	BZ, SK, SW, TT	*				•
1645 SW	9" W	5½"	4"		2¾"	4½" W, 4½" H Back Plate	1-75w Med.	BZ, SK, SW, TT	•				•
1646 SW	9" W	5½"	4"		2¾"	4½" W, 4½" H Back Plate	1-75w Med.	BZ, SK, SW, TT	•	*	•		•
1648 SW	6" W	16"	3½"		13¾"	4½" W, 4½" H Back Plate	2-12 volt, 20w MR-16**	BZ, SK, SW, TT	*				•
1649 SW	9" W	24"	4"		20¾"	4½" W, 6½" H Back Plate	2-12 volt, 20w MR-16**	BZ, SK, SW, TT	*				•

*Fixture comes standard Dark Sky compliant. **MR-16 Xenon bulbs included. For posts and pier mounts, see pages 406-407.

AVAILABLE OPTIONS

ATLANTIS™

- Finish** Satin Black
Glass Etched glass lenses
Details Solid aluminum construction;
dual light source options
See also Atlantis landscape, page 409



1649 SK 



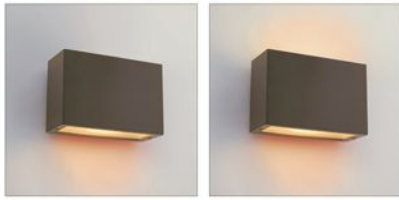

1646 BZ (left), 1646 SK, 1646 SW and 1646 TT will cast light down

1645 BZ (right), 1645 SK, 1645 SW and 1645 TT will cast light up and down



1646 SK 
(pocket down light)



1645 SK 
(pocket up/down light)



1648 SK 



1640 SK





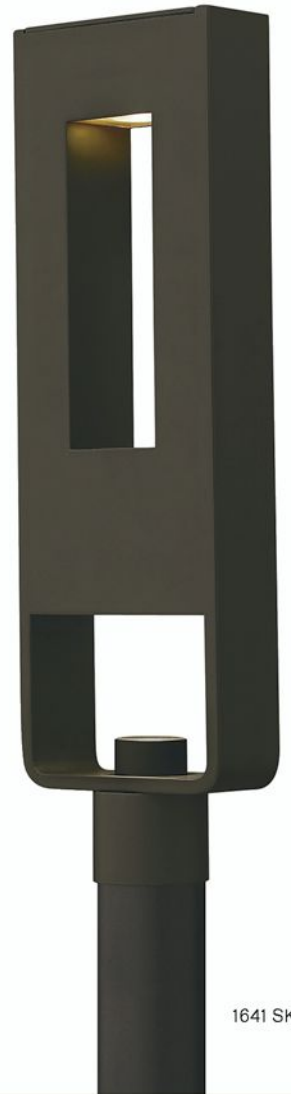

1644 SK



1641 SK

ATLANTIS

Satin Black (SK)

ITEM	WIDTH/DIA.	HEIGHT	EXT.	DEPTH	TOP TO OUTLET	BACK PLATE/CANOPY	BULBS	AVAILABLE FINISHES					
1640 SK	2¾" W	16"	6¾"		8"	4½" W, 4½" H Back Plate	2-12 volt, 20w MR-16*	BZ, SK, SW, TT	*				•
1641 SK	6¾" W	23½"		2¾"		3" Dia. Post Fitter	2-12 volt, 20w MR-16*	BZ, SK, SW, TT	*				•
1644 SK	3" W	24"	7"		12"	4½" W, 4½" H Back Plate	2-12 volt, 20w MR-16*	BZ, SK, SW, TT	*				•
1645 SK	9" W	5½"	4"		2¾"	4½" W, 4½" H Back Plate	1-75w Med.	BZ, SK, SW, TT	•				•
1646 SK	9" W	5½"	4"		2¾"	4½" W, 4½" H Back Plate	1-75w Med.	BZ, SK, SW, TT	•	*	•		•
1648 SK	6" W	16"	3½"		13¾"	4½" W, 4½" H Back Plate	2-12 volt, 20w MR-16*	BZ, SK, SW, TT	*				•
1649 SK	9" W	24"	4"		20¾"	4½" W, 6½" H Back Plate	2-12 volt, 20w MR-16*	BZ, SK, SW, TT	*				•

*Fixture comes standard Dark Sky compliant. **MR-16 Xenon bulbs included. For posts and pier mounts, see pages 406-407.

AVAILABLE OPTIONS

LUNA™

Finish Bronze, Satin Black, Titanium
Glass Etched glass lenses
Details Solid aluminum construction;
dual light source; decorative washboard
reflector; ADA compliant



1660 TT 



1664 TT 





1660 BZ 

1664 BZ 

1660 SK 

1664 SK 

LUNA

Bronze (BZ), Satin Black (SK), Titanium (TT)

ITEM	WIDTH/DIA.	HEIGHT	EXT.	TOP TO OUTLET	BACK PLATE/CANOPY	BULBS	AVAILABLE FINISHES					
1660 BZ	6" W	16"	3½"	10" to 13½"***	6" W, 16" H Back Plate	2-12 volt, 20w MR-16***	BZ, SK, TT	*				•
1660 SK	6" W	16"	3½"	10" to 13½"***	6" W, 16" H Back Plate	2-12 volt, 20w MR-16***	BZ, SK, TT	*				•
1660 TT	6" W	16"	3½"	10" to 13½"***	6" W, 16" H Back Plate	2-12 volt, 20w MR-16***	BZ, SK, TT	*				•
1664 BZ	9" W	24"	4"	11½" to 20½"***	9" W, 24" H Back Plate	2-12 volt, 20w MR-16***	BZ, SK, TT	*				•
1664 SK	9" W	24"	4"	11½" to 20½"***	9" W, 24" H Back Plate	2-12 volt, 20w MR-16***	BZ, SK, TT	*				•
1664 TT	9" W	24"	4"	11½" to 20½"***	9" W, 24" H Back Plate	2-12 volt, 20w MR-16***	BZ, SK, TT	*				•

*Fixture comes standard Dark Sky compliant. **Adjustable mounting hardware. ***MR-16 Xenon bulbs included.

AVAILABLE OPTIONS

LUNA™

Finish Bronze, Satin White, Satin Black, Titanium
Glass Etched glass lenses
Details Solid aluminum construction; dual light source; decorative washboard reflector; ADA compliant



1647 BZ



1647 SW



1647 SK



1647 TT

LUNA

Bronze (BZ), Satin Black (SK), Satin White (SW), Titanium (TT)

ITEM	WIDTH/DIA.	HEIGHT	EXT.	TOP TO OUTLET	BACK PLATE/CANOPY	BULBS	AVAILABLE FINISHES				
1647 BZ	9" W	9"	4"	4½"	4½" W, 6¾" H Back Plate	2-13w CFL**	BZ, SK, SW, TT	*	*	*	
1647 SK	9" W	9"	4"	4½"	4½" W, 6¾" H Back Plate	2-13w CFL**	BZ, SK, SW, TT	*	*	*	
1647 SW	9" W	9"	4"	4½"	4½" W, 6¾" H Back Plate	2-13w CFL**	BZ, SK, SW, TT	*	*	*	
1647 TT	9" W	9"	4"	4½"	4½" W, 6¾" H Back Plate	2-13w CFL**	BZ, SK, SW, TT	*	*	*	

*Luna 1647 comes standard with Energy Saving and Dark Sky configurations. **CFL bulbs included.

AVAILABLE OPTIONS



1666 BZ (left), 1666 SK and 1666 TT will cast light down

1667 BZ (right), 1667 SK and 1667 TT will cast light up and down

LUNA™

Finish Bronze, Satin Black, Titanium
Glass Etched glass lenses
Details Solid aluminum construction; dual light source options



1663 BZ
(ceiling mount)



1666 BZ 
(pocket down light)



1667 BZ 
(pocket up/down light)



1663 SK
(ceiling mount)



1666 SK 
(pocket down light)



1667 SK 
(pocket up/down light)



1663 TT
(ceiling mount)



1666 TT 
(pocket down light)



1667 TT 
(pocket up/down light)

LUNA Bronze (BZ), Satin Black (SK), Titanium (TT)

ITEM	WIDTH/DIA.	HEIGHT	EXT.	TOP TO OUTLET	BACK PLATE/CANOPY	BULBS	AVAILABLE FINISHES				
1663 BZ, 1663 SK, 1663 TT	8" W	7 1/4"				1-75w Med.	BZ, SK, TT	•			•
1666 BZ, 1666 SK, 1666 TT	9" W	5 1/4"	4"	2 3/4"	9" W, 5 1/4" H Back Plate	1-75w Med.	BZ, SK, TT	•	*	•	•
1667 BZ, 1667 SK, 1667 TT	9" W	5 1/4"	4"	2 3/4"	9" W, 5 1/4" H Back Plate	1-75w Med.	BZ, SK, TT	•			•

*Luna 1666 comes standard with Energy Saving and Dark Sky configurations.

AVAILABLE OPTIONS

KUBE™

- Finish** Bronze, Satin Black, Titanium
- Glass** Bronze: Amber etched organic rain;
Satin Black and Titanium:
Clear etched organic rain
- Details** Glass slants to enhance
waterfall effect of light

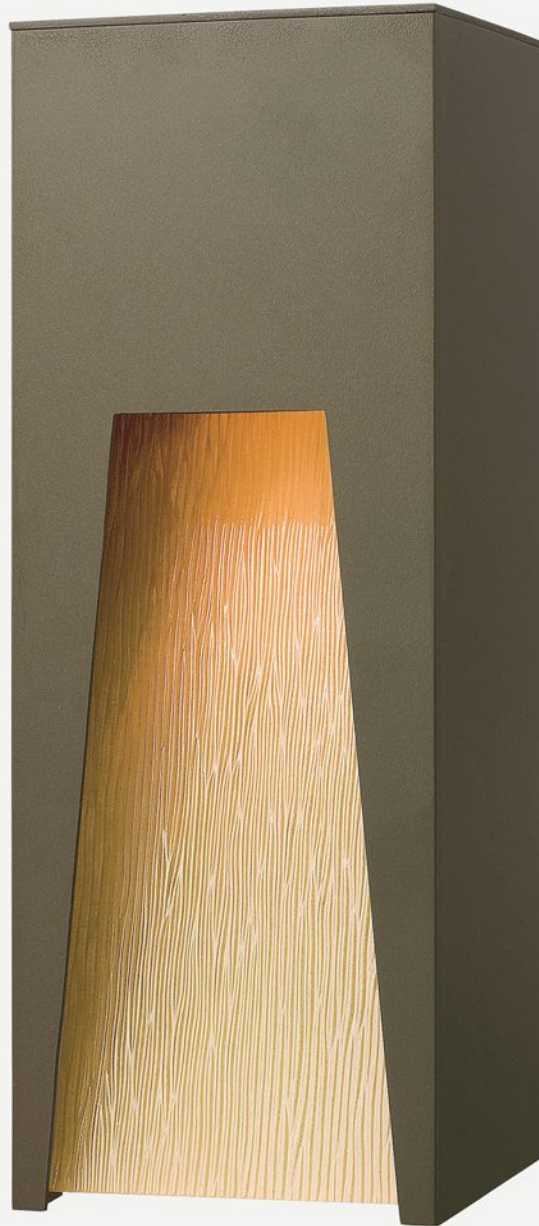

1764 BZ





1760 BZ



1760 SK



1760 TT



(amber glass detail)



(clear glass detail)

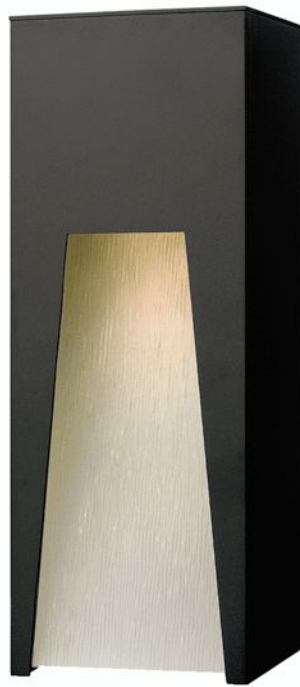





1764 SK



1764 TT

KUBE

Bronze (BZ), Satin Black (SK), Titanium (TT)

ITEM	WIDTH/DIA.	HEIGHT	EXT.	TOP TO OUTLET	BACK PLATE/CANOPY	BULBS	AVAILABLE FINISHES	    
1760 BZ	4½" W	12"	5"	5½"	4½" W, 6¾" H Back Plate	1-50w GU10**	BZ, SK, TT	*
1760 SK	4½" W	12"	5"	5½"	4½" W, 6¾" H Back Plate	1-50w GU10**	BZ, SK, TT	*
1760 TT	4½" W	12"	5"	5½"	4½" W, 6¾" H Back Plate	1-50w GU10**	BZ, SK, TT	*
1764 BZ	6" W	16"	6½"	8"	4½" W, 6¾" H Back Plate	1-50w GU10**	BZ, SK, TT	*
1764 SK	6" W	16"	6½"	8"	4½" W, 6¾" H Back Plate	1-50w GU10**	BZ, SK, TT	*
1764 TT	6" W	16"	6½"	8"	4½" W, 6¾" H Back Plate	1-50w GU10**	BZ, SK, TT	*

*Kube comes standard Dark Sky compliant. When ordering Energy Saving configuration, fixture will meet both Energy Saving and Dark Sky requirements (ESDS). **GU10 bulb included.

AVAILABLE OPTIONS

KUBE™

Finish Bronze, Satin Black, Satin White, Titanium
Glass Etched glass lenses
Details Solid aluminum construction; dual light source options



1763 BZ
(ceiling mount)



1763 SK
(ceiling mount)





1763 SW
(ceiling mount)



1763 TT
(ceiling mount)

KUBE

Bronze (BZ), Satin Black (SK), Satin White (SW), Titanium (TT)

ITEM	WIDTH/DIA.	HEIGHT	EXT.	TOP TO OUTLET	BACK PLATE/CANOPY	BULBS	AVAILABLE FINISHES					
1763 BZ	6" W	6¼"			6" W, 6" L Canopy	1-75w Med.	BZ, SK, SW, TT	•	•	•	•	•
1763 SK	6" W	6¼"			6" W, 6" L Canopy	1-75w Med.	BZ, SK, SW, TT	•	•	•	•	•
1763 SW	6" W	6¼"			6" W, 6" L Canopy	1-75w Med.	BZ, SK, SW, TT	•	•	•	•	•
1763 TT	6" W	6¼"			6" W, 6" L Canopy	1-75w Med.	BZ, SK, SW, TT	•	•	•	•	•

AVAILABLE OPTIONS



1766 BZ, 1766 SK, 1766 SW and 1766 TT (left)
will cast light down

1767 BZ, 1767 SK, 1767 SW and 1767 TT (right)
will cast light up and down



1766 BZ
(pocket down light)



1766 SK
(pocket down light)



1766 SW
(pocket down light)



1766 TT
(pocket down light)



1767 BZ
(pocket up/down light)



1767 SK
(pocket up/down light)



1767 SW
(pocket up/down light)



1767 TT
(pocket up/down light)

KUBE

Bronze (BZ), Satin Black (SK), Satin White (SW), Titanium (TT)

ITEM	WIDTH/DIA.	HEIGHT	EXT.	TOP TO OUTLET	BACK PLATE/CANOPY	BULBS	AVAILABLE FINISHES					
1766 BZ, 1766 SK, 1766 SW, 1766 TT	6" W	6"	6¾"	3"	4½" W, 4½" H Back Plate	1-75w Med.	BZ, SK, SW, TT	•	*	•	•	•
1767 BZ, 1767 SK, 1767 SW, 1767 TT	6" W	6"	6¾"	3"	4½" W, 4½" H Back Plate	1-75w Med.	BZ, SK, SW, TT	•	•	•	•	•

AVAILABLE OPTIONS

TITAN™

Finish Buckeye Bronze, Hematite, Titanium
Glass Organic ribbed etched
Details Indirect wall wash



2054 HE





2054 KZ



2054 TT



2050 HE



2050 KZ



2050 TT

TITAN

Buckeye Bronze (KZ), Hematite (HE), Titanium (TT)

ITEM	WIDTH/DIA.	HEIGHT	EXT.	TOP TO OUTLET	BACK PLATE/CANOPY	BULBS	AVAILABLE FINISHES					
2050 HE	6¾" W	14"	4½"	7"	6¾" W, 14" H Back Plate	1-100w Med.	HE, KZ, TT					
2050 KZ	6¾" W	14"	4½"	7"	6¾" W, 14" H Back Plate	1-100w Med.	HE, KZ, TT					
2050 TT	6¾" W	14"	4½"	7"	6¾" W, 14" H Back Plate	1-100w Med.	HE, KZ, TT					
2054 HE	8½" W	17½"	4¾"	8¾"	8½" W, 17½" H Back Plate	1-100w Med.	HE, KZ, TT					
2054 KZ	8½" W	17½"	4¾"	8¾"	8½" W, 17½" H Back Plate	1-100w Med.	HE, KZ, TT					
2054 TT	8½" W	17½"	4¾"	8¾"	8½" W, 17½" H Back Plate	1-100w Med.	HE, KZ, TT					

AVAILABLE OPTIONS

CASCADE™

- Finish** Bronze, Satin Black, Titanium
- Glass** Satin Black and Titanium:
Clear etched organic rain;
Bronze: Amber etched organic rain
- Details** Solid aluminum construction;
indirect lighting effect;
ADA compliant



1834 BZ 
(pocket wall mount)





1830 BZ 
(pocket wall mount)



1830 TT 
(pocket wall mount)



1830 SK 
(pocket wall mount)



(amber glass detail)



(clear glass detail)



1834 TT 
(pocket wall mount)



1834 SK 
(pocket wall mount)

CASCADE

Bronze (BZ), Satin Black (SK), Titanium (TT)

ITEM	WIDTH/DIA.	HEIGHT	EXT.	TOP TO OUTLET	BACK PLATE/CANOPY	BULBS	AVAILABLE FINISHES					
1830 BZ	8" W	14½"	4"	4¾" to 14¾"***	8" W, 14½" H Back Plate	1-100w Med.	BZ, SK, TT	•	*	•	•	•
1830 SK	8" W	14½"	4"	4¾" to 14¾"***	8" W, 14½" H Back Plate	1-100w Med.	BZ, SK, TT	•	*	•	•	•
1830 TT	8" W	14½"	4"	4¾" to 14¾"***	8" W, 14½" H Back Plate	1-100w Med.	BZ, SK, TT	•	*	•	•	•
1834 BZ	8" W	18"	4"	4¾"	8" W, 18" H Back Plate	1-100w Med.	BZ, SK, TT	•	*	•	•	•
1834 SK	8" W	18"	4"	4¾"	8" W, 18" H Back Plate	1-100w Med.	BZ, SK, TT	•	*	•	•	•
1834 TT	8" W	18"	4"	4¾"	8" W, 18" H Back Plate	1-100w Med.	BZ, SK, TT	•	*	•	•	•

*Cascade comes standard Dark Sky compliant. When ordering with Energy Saving configuration, fixture will meet both Energy Saving and Dark Sky (ESDS) requirements. **Adjustable mounting hardware.

AVAILABLE OPTIONS

SIERRA™

- Finish Spanish Bronze
- Glass Clear seedy and stone
- Details Solid aluminum construction;
natural stone centerpiece



1455 SB

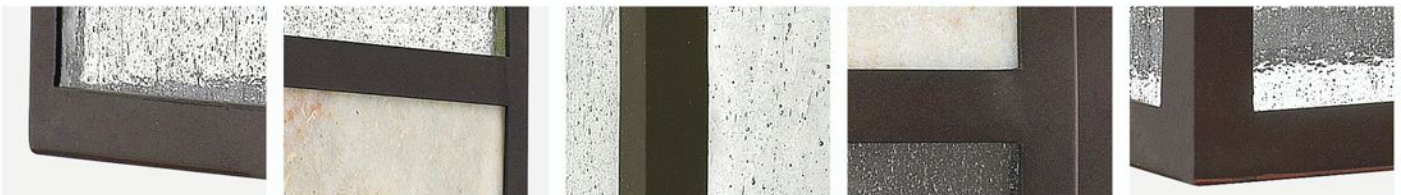



1452 SB







1450 SB



1454 SB

SIERRA

Spanish Bronze (SB)

ITEM	WIDTH/DIA.	HEIGHT	EXT.	TOP TO OUTLET	BACK PLATE/CANOPY	WIRE/CHAIN	BULBS	AVAILABLE FINISHES	   
1450 SB	6" W	8"	7"	4"	5" W, 5" H Back Plate		1-75w Med.	SB	•
1452 SB	6" W	13"			4½" Dia. Canopy	6', 5'	1-75w Med.	SB	•
1454 SB	6" W	13"	7"	6½"	5" W, 7" H Back Plate		1-75w Med.	SB	•
1455 SB	7" W	15"	8"	7½"	5" W, 7" H Back Plate		1-75w Med.	SB	•

For posts and pier mounts, see pages 406-407.

AVAILABLE OPTIONS

DWELL™

- Finish Black
- Glass Clear seedy
- Details Solid aluminum construction; concealed light source; stem hung pendant option



1325 BK

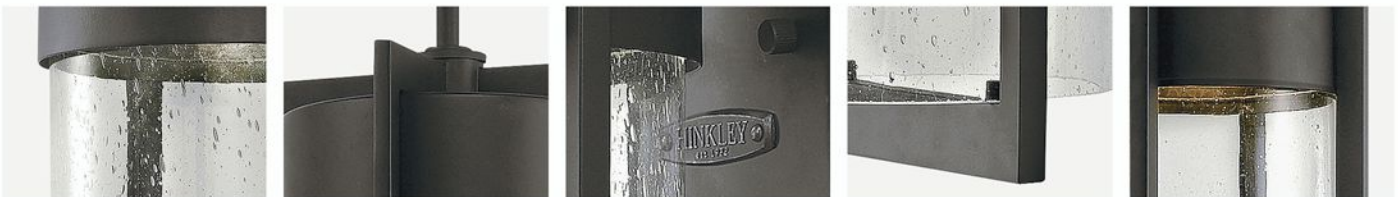



1328 BK



1322 BK



1326 BK



1320 BK



1324 BK



1321 BK

DWELL

Black (BK)

ITEM	WIDTH/ DIA.	HEIGHT	EXT.	TOP TO OUTLET	BACK PLATE/CANOPY	WIRE/ CHAIN	STEMS INCLUDED	BULBS	AVAILABLE FINISHES					
1320 BK	6¼" W	15½"	6½"	5¾"	4½" W, 12" H Back Plate			1-75w Med.**	BK, HE, KZ	*				
1321 BK	8¼" Dia.	27¾"			3" Dia. Post Fitter			1-100w Med.**	BK, HE, KZ	•	*	•		
1322 BK	6¼" Dia.	21¾", 54" Max.***			6" Dia. Canopy	10' Wire	1-6", 2-12"	1-100w Med.**	BK, HE, KZ	•	*	•		
1324 BK	6¼" W	20½"	6½"	5¾"	4½" W, 12" H Back Plate			1-100w Med.**	BK, HE, KZ	•	*	•		
1325 BK	8¼" W	23¾"	8½"	5¾"	4½" W, 12" H Back Plate			1-100w Med.**	BK, HE, KZ	•	*	•		
1326 BK	4½" W	15½"	4¾"	5¾"	4½" W, 12" H Back Plate			1-60w Med.**	BK, HE, KZ	•	*	•		
1328 BK	8¼" Dia.	24½", 57" Max.***			6" Dia. Canopy	10' Wire	1-6", 2-12"	1-100w Med.**	BK	•	*	•		
4312 BK	½" Dia.	12" (stem)							BK, HE, KZ					

AVAILABLE OPTIONS

*Dwell comes standard Dark Sky compliant. When ordering with Energy Saving configuration, fixture will meet both Energy Saving and Dark Sky (ESDS) requirements. **Recommended reflector type or Par type lamp. ***Maximum achievable height with stems included. Additional stems available, see above. For posts and pier mounts, see pages 406-407.

DWELL™

- Finish Buckeye Bronze
- Glass Clear seedy
- Details Solid aluminum construction;
concealed light source;
stem hung pendant option



1325 KZ

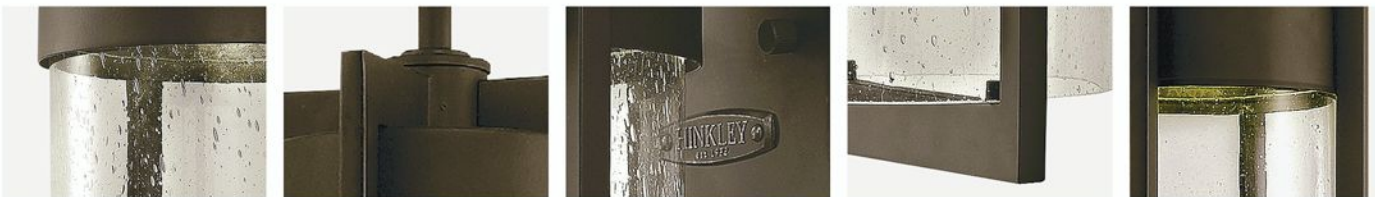



1322 KZ



1326 KZ



1320 KZ



1324 KZ



1321 KZ

DWELL

Buckeye Bronze (KZ)

ITEM	WIDTH/ DIA.	HEIGHT	EXT.	TOP TO OUTLET	BACK PLATE/CANOPY	WIRE/ CHAIN	STEMS INCLUDED	BULBS	AVAILABLE FINISHES					
1320 KZ	6¼" W	15½"	6½"	5¾"	4½" W, 12" H Back Plate			1-75w Med.**	BK, HE, KZ		*			
1321 KZ	8¼" Dia.	27¾"			3" Dia. Post Fitter			1-100w Med.**	BK, HE, KZ	•	*	•		
1322 KZ	6¼" Dia.	21¾", 54" Max.***			6" Dia. Canopy	10' Wire	1-6", 2-12"	1-100w Med.**	BK, HE, KZ	•	*	•		
1324 KZ	6¼" W	20½"	6½"	5¾"	4½" W, 12" H Back Plate			1-100w Med.**	BK, HE, KZ	•	*	•		
1325 KZ	8¼" W	23¾"	8½"	5¾"	4½" W, 12" H Back Plate			1-100w Med.**	BK, HE, KZ	•	*	•		
1326 KZ	4½" W	15½"	4¾"	5¾"	4½" W, 12" H Back Plate			1-60w Med.**	BK, HE, KZ	•	*	•		
4312 KZ	½" Dia.	12" (stem)							BK, HE, KZ					

AVAILABLE OPTIONS

*Dwell comes standard Dark Sky compliant. When ordering with Energy Saving configuration, fixture will meet both Energy Saving and Dark Sky (ESDS) requirements. **Recommended reflector type or Par type lamp. ***Maximum achievable height with stems included. Additional stems available, see above. For posts and pier mounts, see pages 406-407.

DWELL™

- Finish Hematite
- Glass Clear seedy
- Details Solid aluminum construction;
concealed light source;
stem hung pendant option



1325 HE

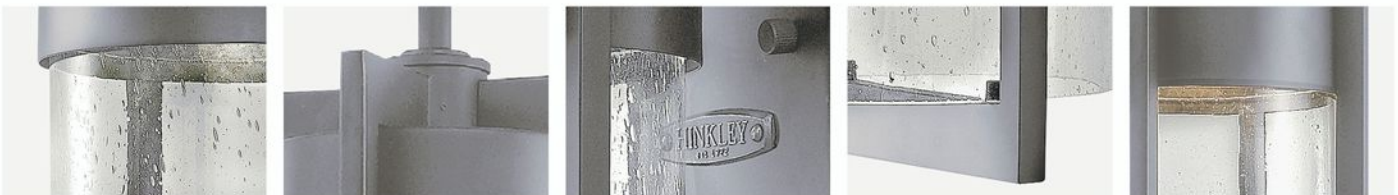



1322 HE



1326 HE



1320 HE



1324 HE



1321 HE

DWELL Hematite (HE)

ITEM	WIDTH/ DIA.	HEIGHT	EXT.	TOP TO OUTLET	BACK PLATE/CANOPY	WIRE/ CHAIN	STEMS INCLUDED	BULBS	AVAILABLE FINISHES				
1320 HE	6¼" W	15½"	6½"	5¾"	4½" W, 12" H Back Plate			1-75w Med.**	BK, HE, KZ		*		
1321 HE	8¼" Dia.	27¾"			3" Dia. Post Fitter			1-100w Med.**	BK, HE, KZ	•	*	•	
1322 HE	6¼" Dia.	21¾", 54" Max.***			6" Dia. Canopy	10' Wire	1-6", 2-12"	1-100w Med.**	BK, HE, KZ	•	*	•	
1324 HE	6¼" W	20½"	6½"	5¾"	4½" W, 12" H Back Plate			1-100w Med.**	BK, HE, KZ	•	*	•	
1325 HE	8¼" W	23¾"	8½"	5¾"	4½" W, 12" H Back Plate			1-100w Med.**	BK, HE, KZ	•	*	•	
1326 HE	4½" W	15½"	4¾"	5¾"	4½" W, 12" H Back Plate			1-60w Med.**	BK, HE, KZ	•	*	•	
4312 HE	½" Dia.	12" (stem)							BK, HE, KZ				

AVAILABLE OPTIONS

*Dwell comes standard Dark Sky compliant. When ordering with Energy Saving configuration, fixture will meet both Energy Saving and Dark Sky (ESDS) requirements. **Recommended reflector type or Par type lamp. ***Maximum achievable height with stems included. Additional stems available, see above. For posts and pier mounts, see pages 406-407.

REEF™

Finish Hematite
 Glass Inside etched
 Details Cast aluminum construction
 See also Reef landscape, page 409



1952 HE



1950 HE



1951 HE



1956 HE



1954 HE

REEF

Hematite (HE)

ITEM	WIDTH/DIA.	HEIGHT	EXT.	TOP TO OUTLET	BACK PLATE/CANOPY	WIRE/CHAIN	BULBS	AVAILABLE FINISHES					
1950 HE	7¾" W	10¾"	8¾"	4"	4½" W, 7" H Back Plate		1-75w Med.	HE, VZ	•				•
1951 HE	9" Dia.	16¼"			3" Dia. Post Fitter		1-100w Med.	HE, VZ	•				•
1952 HE	9" Dia.	15"			5½" Dia. Canopy	6', 5'	1-100w Med.	HE, VZ	•				•
1954 HE	9" W	12¾"	10"	4¼"	4½" W, 7" H Back Plate		1-100w Med.	HE, VZ	•				•
1956 HE	5½" W	8"	6½"	2¾"	4½" W, 5¼" H Back Plate		1-60w Med.	HE, VZ	•				•

For posts and pier mounts, see pages 406-407.

AVAILABLE OPTIONS

REEF™

Finish Victorian Bronze
 Glass Inside etched
 Details Cast aluminum construction
 See also Reef landscape, page 409



1950 VZ



1952 VZ



1954 VZ



1956 VZ



1951 VZ

REEF

Victorian Bronze (VZ)

ITEM	WIDTH/DIA.	HEIGHT	EXT.	TOP TO OUTLET	BACK PLATE/CANOPY	WIRE/CHAIN	BULBS	AVAILABLE FINISHES					
1950 VZ	7¾" W	10¾"	8¾"	4"	4½" W, 7" H Back Plate		1-75w Med.	HE, VZ	•				•
1951 VZ	9" Dia.	16¼"			3" Dia. Post Fitter		1-100w Med.	HE, VZ	•				•
1952 VZ	9" Dia.	15"			5½" Dia. Canopy	6', 5'	1-100w Med.	HE, VZ	•				•
1954 VZ	9" W	12¾"	10"	4¼"	4½" W, 7" H Back Plate		1-100w Med.	HE, VZ	•				•
1956 VZ	5½" W	8"	6½"	2¾"	4½" W, 5¼" H Back Plate		1-60w Med.	HE, VZ	•				•

For posts and pier mounts, see pages 406-407.

AVAILABLE OPTIONS

HARBOR™

- Finish Titanium
- Glass Etched seeded bound
- Details Cast aluminum and brass construction
- See also Harbor landscape, page 409



2579 TT





2572 TT



2574 TT



2570 TT



2573 TT



2575 TT







2576 TT
(pier mount)



2571 TT

HARBOR

Titanium (TT)

ITEM	WIDTH/DIA.	HEIGHT	EXT.	TOP TO OUTLET	BACK PLATE/CANOPY	WIRE/CHAIN	BULBS	AVAILABLE FINISHES					
2570 TT	7" W	10½"	7¾"	4¾"	4½" W, 7" H Back Plate		1-60w Med.	AR, TT	•	•	•		
2571 TT	11" W	19½"			3" Dia. Post Fitter		1-100w Med.	AR, TT	•				
2572 TT	11" W	19"			5" Dia. Canopy	6', 5'	1-100w Med.	AR, TT	•	•	•		
2573 TT	12¼" W	7"					2-60w Med.	AR, TT	•				
2574 TT	9" W	13½"	10"	6"	4½" W, 9" H Back Plate		1-75w Med.	AR, TT	•	•	•		
2575 TT	11" W	16¾"	11¾"	8"	4½" W, 12" H Back Plate		1-100w Med.	AR, TT	•	•	•		
2576 TT	11" W	17"			Pier Mount		1-100w Med.	AR, TT	•				
2579 TT	13" W	20½"	13¾"	13¾"	4½" W, 14¼" H Back Plate		1-100w Med.	AR, TT	•	•	•		

For posts and pier mounts, see pages 406-407.

AVAILABLE OPTIONS

HARBOR™

- Finish Anchor Bronze
Glass Etched seeded bound
Details Cast aluminum and brass construction
See also Harbor landscape, page 409



2579 AR





2572 AR



2574 AR



2570 AR



2573 AR



2575 AR







2576 AR
(pier mount)



2571 AR

HARBOR

Anchor Bronze (AR)

ITEM	WIDTH/DIA.	HEIGHT	EXT.	TOP TO OUTLET	BACK PLATE/CANOPY	WIRE/CHAIN	BULBS	AVAILABLE FINISHES					
2570 AR	7" W	10½"	7¾"	4¾"	4½" W, 7" H Back Plate		1-60w Med.	AR, TT	•	•	•		
2571 AR	11" W	19½"			3" Dia. Post Fitter		1-100w Med.	AR, TT	•				
2572 AR	11" W	19"			5" Dia. Canopy	6', 5'	1-100w Med.	AR, TT	•	•	•		
2573 AR	12¼" W	7"					2-60w Med.	AR, TT	•				
2574 AR	9" W	13½"	10"	6"	4½" W, 9" H Back Plate		1-75w Med.	AR, TT	•	•	•		
2575 AR	11" W	16¾"	11¾"	8"	4½" W, 12" H Back Plate		1-100w Med.	AR, TT	•	•	•		
2576 AR	11" W	17"			Pier Mount		1-100w Med.	AR, TT	•				
2579 AR	13" W	20½"	13¾"	13¾"	4½" W, 14¼" H Back Plate		1-100w Med.	AR, TT	•	•	•		

For posts and pier mounts, see pages 406-407.

AVAILABLE OPTIONS

BOLLA™

- Finish** Olde Bronze
Glass Light amber seedy
Details Solid brass construction;
heavy cast ball transition detail
- See also** Bolla chandeliers, pages 72-83
Bolla bath, pages 236-238
Bolla landscape, page 410







2639 OB





BOLLA Olde Bronze (OB)

ITEM	WIDTH/DIA.	HEIGHT	EXT.	TOP TO OUTLET	BACK PLATE/CANOPY	WIRE/CHAIN	BULBS	AVAILABLE FINISHES					
2630 OB	7¼" W	12¼"	9"	7"	4½" W, 7¼" H Back Plate		1-60w Med.	BK, OB	•	•			
2631 OB	11" W	20½"			3" Dia. Post Fitter		3-40w Cand.	BK, OB	•	•			
2632 OB	11" W	20½"			5" Dia. Canopy	6', 5'	3-40w Cand.	BK, OB	•	•			
2633 OB	16¾" W	8"					2-75w Med.	BK, OB	•	•			
2634 OB	9" W	15¾"	10½"	8"	4½" W, 7¼" H Back Plate		2-40w Cand.	BK, OB	•	•			
2635 OB	11" W	18¾"	12½"	9¾"	4½" W, 9" H Back Plate		3-40w Cand.	BK, OB	•	•			
2636 OB	6" W	11"	6¾"	3"	5" W, 6" H Back Plate		1-60w Med.	BK, OB	•	•			
2639 OB	14" W	26"	16"	12¾"	4½" W, 11½" H Back Plate		4-40w Cand.	BK, OB	•	•			

For posts and pier mounts, see pages 406-407.

AVAILABLE OPTIONS

BOLLA™

- Finish** Black
- Glass** Clear inside-etched seeded
- Details** Sturdy aluminum construction; heavy cast ball transition detail
- See also** Bolla chandeliers, pages 72-83
Bolla bath, pages 236-238
Bolla landscape, page 410



2639 BK





2632 BK



2634 BK



2633 BK



2636 BK



2630 BK







2635 BK



2631 BK

BOLLA

Black (BK)

ITEM	WIDTH/DIA.	HEIGHT	EXT.	TOP TO OUTLET	BACK PLATE/CANOPY	WIRE/CHAIN	BULBS	AVAILABLE FINISHES					
2630 BK	7¼" W	12¼"	9"	7"	4½" W, 7¼" H Back Plate		1-60w Med.	BK, OB	•			•	
2631 BK	11" W	20½"			3" Dia. Post Fitter		3-40w Cand.	BK, OB	•			•	
2632 BK	11" W	20½"			5" Dia. Canopy	6', 5'	3-40w Cand.	BK, OB	•			•	
2633 BK	16¾" W	8"					2-75w Med.	BK, OB	•			•	
2634 BK	9" W	15¾"	10½"	8"	4½" W, 7¼" H Back Plate		2-40w Cand.	BK, OB	•			•	
2635 BK	11" W	18¾"	12½"	9¾"	4½" W, 9" H Back Plate		3-40w Cand.	BK, OB	•			•	
2636 BK	6" W	11"	6¾"	3"	5" W, 6" H Back Plate		1-60w Med.	BK, OB	•			•	
2639 BK	14" W	26"	16"	12¾"	4½" W, 11½" H Back Plate		4-40w Cand.	BK, OB	•			•	

For posts and pier mounts, see pages 406-407.

AVAILABLE OPTIONS

SAN MATEO™

Finish Regency Bronze
Glass Champagne optic
Details Cast aluminum construction;
decorative cast detailing



1255 RB





1252 RB



1254 RB



1253 RB



1256 RB







1250 RB



1251 RB

SAN MATEO

Regency Bronze (RB)

ITEM	WIDTH/DIA.	HEIGHT	EXT.	TOP TO OUTLET	BACK PLATE/CANOPY	WIRE/CHAIN	BULBS	AVAILABLE FINISHES				
1250 RB	7" W	14"	9¼"	7"	4½" W, 7" H Back Plate		1-60w Med.	RB				
1251 RB	11½" Dia.	23½"			3" Dia. Post Fitter		3-40w Cand.	RB				
1252 RB	11½" Dia.	24¼"			5½" Dia. Canopy	6', 5'	3-40w Cand.	RB				
1253 RB	16" Dia.	9½"					3-60w Med.	RB				
1254 RB	9½" W	23¼"	12¼"	13¾"	5" W, 9" H Back Plate		3-40w Cand.	RB				
1255 RB	11½" W	26¾"	13¼"	13¾"	5" W, 9" H Back Plate		3-40w Cand.	RB				
1256 RB	5¾" W	10¼"	6½"	3¾"	5" W, 6½" H Back Plate		1-60w Med.	RB				

For posts and pier mounts, see pages 406-407.

AVAILABLE OPTIONS

KEY WEST™

Finish Regency Bronze
Glass Antique vanilla
Details Cast aluminum construction;
decorative cast detailing







1615 RB





KEY WEST

Regency Bronze (RB)

ITEM	WIDTH/DIA.	HEIGHT	EXT.	TOP TO OUTLET	BACK PLATE/CANOPY	WIRE/CHAIN	BULBS	AVAILABLE FINISHES					
1610 RB	7" W	16¼"	9¼"	8¾"	4½" W, 7" H Back Plate		1-60w Med.	RB	•				
1611 RB	12" Dia.	21¼"			3" Dia. Post Fitter		1-100w Med.	RB	•				
1612 RB	12" Dia.	23¾"			5½" Dia. Canopy	6', 5'	1-100w Med.	RB	•				
1613 RB	15" Dia.	8¼"					2-60w Med.	RB	•				
1614 RB	9" W	21"	12¼"	12½"	4½" W, 9" H Back Plate		1-75w Med.	RB	•				
1615 RB	12" W	27"	14¾"	13¾"	4½" W, 9" H Back Plate		1-100w Med.	RB	•				
1616 RB	5½" W	8½"	6¾"	3"	4½" W, 4½" H Back Plate		1-60w Med.	RB	•				

For posts and pier mounts, see pages 406-407.

AVAILABLE OPTIONS

HANNA™

Finish Metro Bronze
 Glass Inside-white etched
 Details Solid brass construction



2541 MT



2545 MT



2542 MT



2544 MT



2540 MT

HANNA

Metro Bronze (MT)

ITEM	WIDTH/DIA.	HEIGHT	EXT.	TOP TO OUTLET	BACK PLATE/CANOPY	WIRE/CHAIN	BULBS	AVAILABLE FINISHES					
2540 MT	6" W	10½"	6¾"	2½"	4¾" W, 4¾" H Back Plate		1-60w Med.	MT	•	•	•		
2541 MT	11" Dia.	27¼"			3" Dia. Post Fitter		1-100w Med.	MT	•				
2542 MT	11" Dia.	26¼"			5½" Dia. Canopy	6', 5'	1-100w Med.	MT	•	•	•		
2544 MT	9" W	19"	11¼"	7"	4¾" W, 14" H Back Plate		1-75w Med.	MT	•	•	•		
2545 MT	11" W	26¼"	12¾"	10"	4¾" W, 20¼" H Back Plate		1-100w Med.	MT	•	•	•		

For posts and pier mounts, see pages 406-407.

AVAILABLE OPTIONS

OAK PARK™

Finish Copper Bronze
 Glass Honey art
 Details Solid brass construction;
 cast brass detailing



2392 CB



2394 CB



2390 CB







2396 CB



2391 CB

OAK PARK

Copper Bronze (CB)

ITEM	WIDTH/DIA.	HEIGHT	EXT.	TOP TO OUTLET	BACK PLATE/CANOPY	WIRE/CHAIN	BULBS	AVAILABLE FINISHES					
2390 CB	8½" W	13¾"	9½"	4¼"	4¾" W, 7" H Back Plate		1-75w Med.	CB	•	•	•		
2391 CB	10½" Dia.	21½"			3" Dia. Post Fitter		1-100w Med.	CB	•				
2392 CB	10½" Dia.	17¾"			5½" Dia. Canopy	6', 5'	3-40w Cand.	CB	•	•	•		
2394 CB	10½" W	22½"	12¾"	8½"	4¾" W, 16¼" H Back Plate		1-100w Med.	CB	•	•	•		
2396 CB	6" W	11¼"	7"	3¾"	4¾" W, 7" H Back Plate		1-60w Med.	CB	•	•	•		

For posts and pier mounts, see pages 406-407.

AVAILABLE OPTIONS

ELM™

Finish Regency Bronze
Glass Distressed amber etched
Details Hand-made sculptural detailing



1155 RB
(pocket wall mount)





1152 RB



1154 RB
(pocket wall mount)



1150 RB
(pocket wall mount)



1151 RB

ELM

Regency Bronze (RB)

ITEM	WIDTH/DIA.	HEIGHT	EXT.	TOP TO OUTLET	BACK PLATE/CANOPY	WIRE/CHAIN	BULBS	AVAILABLE FINISHES				
1150 RB	8" W	10"	5½"	5"	8" W, 10" H Back Plate		1-100w Med.	RB	•			•
1151 RB	9" Dia.	19"			3" Dia. Post Fitter		1-100w Med.	RB	•			•
1152 RB	8½" Dia.	17½"			6½" Dia. Canopy	6', 5'	1-100w Med.	RB	•			•
1154 RB	9" W	14"	5½"	7"	9" W, 14" H Back Plate		1-100w Med.	RB	•			•
1155 RB	11" W	18"	7"	9"	11" W, 18" H Back Plate		1-100w Med.	RB	•			•

For posts and pier mounts, see pages 406-407.

AVAILABLE OPTIONS

CORDILLERA™

- Finish** Buckeye Bronze
Glass Light amber etched
Details Solid aluminum construction; fixtures are slightly overscaled; tall tubular closed glass; three-quarter trim rings
- See also** Cordillera chandeliers, pages 122-123



1695 KZ





1690 KZ



1694 KZ



1691 KZ

CORDILLERA

Buckeye Bronze (KZ)

ITEM	WIDTH/DIA.	HEIGHT	EXT.	TOP TO OUTLET	BACK PLATE/CANOPY	WIRE/CHAIN	BULBS	AVAILABLE FINISHES	    
1690 KZ	4½" W	16"	7½"	8"	4½" W, 11" H Back Plate		1-75w Med.	KZ	•
1691 KZ	7¾" W	23"			3" Dia. Post Fitter		1-100w Med.	KZ	•
1694 KZ	4¾" W	18"	8½"	9"	4½" W, 11" H Back Plate		1-100w Med.	KZ	•
1695 KZ	4¾" W	24"	8½"	12"	4½" W, 11" H Back Plate		1-100w Med.	KZ	•

For posts and pier mounts, see pages 406-407.

AVAILABLE OPTIONS

CASA™

- Finish** Olde Black
Glass Light amber etched
Details Solid aluminum construction;
square shaped wrought iron features
hand-forged twisted scrollwork
- See also** Casa chandeliers, pages 126-129
Casa bath, page 243



1145 OL





1142 OL



1140 OL



1144 OL



1141 OL

CASA

Olde Black (OL)

ITEM	WIDTH/DIA.	HEIGHT	EXT.	TOP TO OUTLET	BACK PLATE/CANOPY	WIRE/CHAIN	BULBS	AVAILABLE FINISHES					
1140 OL	7" W	13"	8"	6¾"	4½" W, 7" H Back Plate		1-60w Med.	OL	•	•	•		
1141 OL	11¾" Dia.	24"			3" Dia. Post Fitter		3-60w Cand.	OL	•				
1142 OL	11¾" Dia.	18½"			5¼" Dia. Canopy	6', 5'	1-100w Med.	OL	•	•	•		
1144 OL	9¾" W	17¼"	9¼"	9½"	4½" W, 9" H Back Plate		1-75w Med.	OL	•	•	•		
1145 OL	11¾" W	20¾"	11¼"	10¾"	4½" W, 9" H Back Plate		1-100w Med.	OL	•	•	•		

For posts and pier mounts, see pages 406-407.

AVAILABLE OPTIONS

THISTLEDOWN™

Finish Victorian Bronze

Glass Amber linen

Details Solid aluminum construction;
industrial yoke-mount detailing

See also Thistledown chandeliers, pages 100-102

Thistledown bath, page 242

Thistledown landscape, page 410



1285 VZ





1282 VZ



1280 VZ



4171 VZ



1286 VZ







1284 VZ



1281 VZ

THISTLEDOWN

Victorian Bronze (VZ)

ITEM	WIDTH/DIA.	HEIGHT	EXT.	TOP TO OUTLET	BACK PLATE/CANOPY	WIRE/CHAIN	BULBS	AVAILABLE FINISHES					
1280 VZ	8½" W	13¼"	10"	7"	5" W, 9" H Back Plate		1-60w Med.	VZ	•	•	•		
1281 VZ	12¾" Dia.	22½"			3" Dia. Post Fitter		1-100w Med.	VZ	•				
1282 VZ	12¾" Dia.	20¾"			5¾" Dia. Canopy	6', 5'	1-100w Med.	VZ	•	•	•		
1284 VZ	10½" W	16"	11½"	8½"	5" W, 9" H Back Plate		1-75w Med.	VZ	•	•	•		
1285 VZ	12¾" W	20½"	14¾"	11"	5" W, 12" H Back Plate		1-100w Med.	VZ	•	•	•		
1286 VZ	6½" W	9¾"	7½"	5¼"	5" W, 7" H Back Plate		1-60w Med.	VZ	•	•	•		
4171 VZ	15¼" Dia.	8"					3-60w Med.	VZ	•				

For posts and pier mounts, see pages 406-407.

AVAILABLE OPTIONS

AURORA™

Finish Metro Bronze
Glass Amber etched seeded
Details Solid brass construction



2289 MT





2282 MT



2284 MT



2280 MT







2285 MT



2281 MT

AURORA

Metro Bronze (MT)

ITEM	WIDTH/DIA.	HEIGHT	EXT.	TOP TO OUTLET	BACK PLATE/CANOPY	WIRE/CHAIN	BULBS	AVAILABLE FINISHES	    
2280 MT	7" W	11½"	8½"	6½"	4½" W, 7" H Back Plate		1-60w Med.	MT	•
2281 MT	11" Dia.	19"			3" Dia. Post Fitter		1-100w Med.	MT	•
2282 MT	11" Dia.	18¾"			5¼" Dia. Canopy	6', 5'	1-100w Med.	MT	•
2284 MT	9" W	15"	10¾"	8¼"	4½" W, 9" H Back Plate		1-75w Med.	MT	•
2285 MT	11" W	18"	13"	10"	4½" W, 14" H Back Plate		1-100w Med.	MT	•
2289 MT	13" W	21½"	15"	12"	4½" W, 14" H Back Plate		1-100w Med.	MT	•

For posts and pier mounts, see pages 406-407.

AVAILABLE OPTIONS

LEDGEWOOD™

- Finish** Museum Bronze
Glass Champagne inside etched
Details Cast aluminum construction;
unique oval shaped design
See also LedgeWood landscape, page 409



1129 MR





1122 MR



1125 MR



1120 MR



1126 MR







1124 MR



1121 MR

LEDGEWOOD

Museum Bronze (MR)

ITEM	WIDTH/DIA.	HEIGHT	EXT.	TOP TO OUTLET	BACK PLATE/CANOPY	WIRE/CHAIN	BULBS	AVAILABLE FINISHES					
1120 MR	7½" W	10½"	6½"	6"	4½" W, 7" H Back Plate		1-60w Med.	MR, VK	•	•	•	•	
1121 MR	13" W	20¾"			3" Dia. Post Fitter		1-100w Med.	MR, VK	•			•	
1122 MR	13" W	19¾"			5" Dia. Canopy	6', 5'	1-100w Med.	MR, VK	•	•	•		
1124 MR	8" W	12"	7¼"	6¾"	4½" W, 10" H Back Plate		1-75w Med.	MR, VK	•	•	•	•	
1125 MR	10" W	15½"	9¼"	8¾"	4½" W, 10" H Back Plate		1-100w Med.	MR, VK	•	•	•	•	
1126 MR	6½" W	7¼"	6"	3¾"	4½" W, 5½" H Back Plate		1-60w Med.	MR, VK	•			•	
1129 MR	13" W	19½"	11¼"	11"	5" W, 13" H Back Plate		1-100w Med.	MR, VK	•	•	•	•	

For posts and pier mounts, see pages 406-407.

AVAILABLE OPTIONS

LEDGEWOOD™

Finish Vintage Black

Glass Cased opal

Details Cast aluminum construction;
unique oval shaped design

See also Ledgewood landscape, page 409



1129 VK





1122 VK



1125 VK



1120 VK



1126 VK



1124 VK



1121 VK

LEDGEWOOD

Vintage Black (VK)

ITEM	WIDTH/DIA.	HEIGHT	EXT.	TOP TO OUTLET	BACK PLATE/CANOPY	WIRE/CHAIN	BULBS	AVAILABLE FINISHES					
1120 VK	7½" W	10½"	6½"	6"	4½" W, 7" H Back Plate		1-60w Med.	MR, VK	•	•	•	•	
1121 VK	13" W	20¾"			3" Dia. Post Fitter		1-100w Med.	MR, VK	•			•	
1122 VK	13" W	19¾"			5" Dia. Canopy	6', 5'	1-100w Med.	MR, VK	•	•	•		
1124 VK	8" W	12"	7¼"	6¾"	4½" W, 10" H Back Plate		1-75w Med.	MR, VK	•	•	•	•	
1125 VK	10" W	15½"	9¼"	8¾"	4½" W, 10" H Back Plate		1-100w Med.	MR, VK	•	•	•	•	
1126 VK	6½" W	7¼"	6"	3¾"	4½" W, 5½" H Back Plate		1-60w Med.	MR, VK	•			•	
1129 VK	13" W	19½"	11¼"	11"	5" W, 13" H Back Plate		1-100w Med.	MR, VK	•	•	•	•	

For posts and pier mounts, see pages 406-407.

AVAILABLE OPTIONS

CASTELLE™

- Finish Bronze
- Glass Ribbed etched amber accented by etched amber corner panels
- Details Cast aluminum construction



1395 BZ





1392 BZ



1390 BZ



1394 BZ



1396 BZ







1397 BZ
(pier mount)



1391 BZ

CASTELLE

Bronze (BZ)

ITEM	WIDTH/DIA.	HEIGHT	EXT.	TOP TO OUTLET	BACK PLATE/CANOPY	WIRE/CHAIN	BULBS	AVAILABLE FINISHES					
1390 BZ	6" W	15"	7"	6¼"	4¼" W, 12¼" H Back Plate		1-100w Med.	BK, BZ	•				
1391 BZ	7" W	16½"			3" Dia. Post Fitter		1-100w Med.	BK, BZ	•				
1392 BZ	7" W	15¾"			5" Dia. Canopy	6', 5'	1-100w Med.	BK, BZ	•				
1394 BZ	7" W	13¼"	8¼"	5¾"	4¾" W, 10¼" H Back Plate		1-100w Med.	BK, BZ	•				
1395 BZ	7" W	18"	8¼"	7"	4¾" W, 15" H Back Plate		1-100w Med.	BK, BZ	•				
1396 BZ	6" W	11½"	7"	4¾"	4¼" W, 8¾" H Back Plate		1-75w Med.	BK, BZ	•				
1397 BZ	8½" W	12¾"					1-100w Med.	BK, BZ	•				

For posts and pier mounts, see pages 406-407.

AVAILABLE OPTIONS

CASTELLE™

- Finish Black
- Glass Ribbed etched accented by etched corner panels
- Details Cast aluminum construction



1395 BK

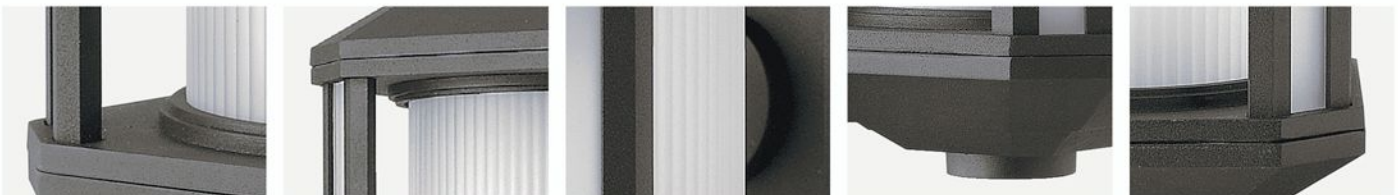



1392 BK



1390 BK



1394 BK



1396 BK







1397 BK
(pier mount)



1391 BK

CASTELLE

Black (BK)

ITEM	WIDTH/DIA.	HEIGHT	EXT.	TOP TO OUTLET	BACK PLATE/CANOPY	WIRE/CHAIN	BULBS	AVAILABLE FINISHES					
1390 BK	6" W	15"	7"	6¼"	4¼" W, 12¼" H Back Plate		1-100w Med.	BK, BZ	•				
1391 BK	7" W	16½"			3" Dia. Post Fitter		1-100w Med.	BK, BZ	•				
1392 BK	7" W	15¾"			5" Dia. Canopy	6', 5'	1-100w Med.	BK, BZ	•				
1394 BK	7" W	13¼"	8¼"	5¾"	4¾" W, 10¼" H Back Plate		1-100w Med.	BK, BZ	•				
1395 BK	7" W	18"	8¼"	7"	4¾" W, 15" H Back Plate		1-100w Med.	BK, BZ	•				
1396 BK	6" W	11½"	7"	4¾"	4¼" W, 8¾" H Back Plate		1-75w Med.	BK, BZ	•				
1397 BK	8½" W	12¾"					1-100w Med.	BK, BZ	•				

For posts and pier mounts, see pages 406-407.

AVAILABLE OPTIONS

BUCKLEY™

Finish Olde Bronze
 Glass Etched amber
 Details Cast aluminum construction



1374 OB



1372 OB



1371 OB





1370 OB



1376 OB

BUCKLEY

Olde Bronze (OB)

ITEM	WIDTH/DIA.	HEIGHT	EXT.	TOP TO OUTLET	BACK PLATE/CANOPY	WIRE/CHAIN	BULBS	AVAILABLE FINISHES					
1370 OB	7½" W	15¾"	9½"	5¼"	5" W, 10½" H Back Plate		1-100w Med.	BK, OB	•				•
1371 OB	9" W	20½"			3" Dia. Post Fitter		1-100w Med.	BK, OB	•				•
1372 OB	9" W	18¾"			4¾" Dia. Canopy	6', 5'	1-100w Med.	BK, OB	•				•
1374 OB	9" W	18½"	11"	5¼"	5" W, 10½" H Back Plate		1-100w Med.	BK, OB	•				•
1376 OB	6" W	11¼"	7¾"	4¾"	4½" W, 8¾" H Back Plate		1-75w Med.	BK, OB	•				•

For posts and pier mounts, see pages 406-407.

AVAILABLE OPTIONS

BUCKLEY™

Finish Black
 Glass Cased opal
 Details Cast aluminum construction



1372 BK



1374 BK



1376 BK



1370 BK



1371 BK

BUCKLEY

Black (BK)

ITEM	WIDTH/DIA.	HEIGHT	EXT.	TOP TO OUTLET	BACK PLATE/CANOPY	WIRE/CHAIN	BULBS	AVAILABLE FINISHES					
1370 BK	7½" W	15¾"	9½"	5¼"	5" W, 10½" H Back Plate		1-100w Med.	BK, OB	•				•
1371 BK	9" W	20½"			3" Dia. Post Fitter		1-100w Med.	BK, OB	•				•
1372 BK	9" W	18¾"			4¾" Dia. Canopy	6', 5'	1-100w Med.	BK, OB	•				•
1374 BK	9" W	18½"	11"	5¼"	5" W, 10½" H Back Plate		1-100w Med.	BK, OB	•				•
1376 BK	6" W	11¼"	7¾"	4¾"	4½" W, 8¼" H Back Plate		1-75w Med.	BK, OB	•				•

For posts and pier mounts, see pages 406-407.

AVAILABLE OPTIONS

STRATFORD™

Finish Auburn
 Glass Amber linen seedy panels
 Details Cast aluminum construction



1356 AU



1350 AU



1352 AU



1351 AU





1355 AU



1354 AU

STRATFORD

Auburn (AU)

ITEM	WIDTH/DIA.	HEIGHT	EXT.	TOP TO OUTLET	BACK PLATE/CANOPY	WIRE/CHAIN	BULBS	AVAILABLE FINISHES					
1350 AU	7½" W	12½"	8¾"	3½"	5¼" W, 8" H Back Plate		1-60w Med.	AU, MB	•	•	•	•	•
1351 AU	9½" W	21"			3" Dia. Post Fitter		1-100w Med.	AU, MB	•				
1352 AU	9½" W	15½"			4¾" Dia. Canopy	6', 5'	1-100w Med.	AU, MB	•	•	•	•	•
1354 AU	9½" W	16"	11"	3¾"	6" W, 9¾" H Back Plate		1-75w Med.	AU, MB	•	•	•	•	•
1355 AU	11" W	18"	12½"	3¾"	5¾" W, 9½" H Back Plate		1-100w Med.	AU, MB	•	•	•	•	•
1356 AU	6" W	10¾"	7"	3"	4½" W, 6" H Back Plate		1-60w Med.	AU, MB	•	•	•	•	•

For posts and pier mounts, see pages 406-407.

AVAILABLE OPTIONS

STRATFORD™

Finish Museum Black
 Glass White linen seedy panels
 Details Cast aluminum construction



1352 MB



1350 MB



1356 MB



1354 MB



1355 MB



1351 MB

STRATFORD

Museum Black (MB)

ITEM	WIDTH/DIA.	HEIGHT	EXT.	TOP TO OUTLET	BACK PLATE/CANOPY	WIRE/CHAIN	BULBS	AVAILABLE FINISHES					
1350 MB	7½" W	12½"	8¾"	3½"	5¼" W, 8" H Back Plate		1-60w Med.	AU, MB	•	•	•	•	•
1351 MB	9½" W	21"			3" Dia. Post Fitter		1-100w Med.	AU, MB	•				
1352 MB	9½" W	15½"			4¾" Dia. Canopy	6', 5'	1-100w Med.	AU, MB	•	•	•	•	•
1354 MB	9½" W	16"	11"	3¾"	6" W, 9¾" H Back Plate		1-75w Med.	AU, MB	•	•	•	•	•
1355 MB	11" W	18"	12½"	3¾"	5¾" W, 9½" H Back Plate		1-100w Med.	AU, MB	•	•	•	•	•
1356 MB	6" W	10¾"	7"	3"	4½" W, 6" H Back Plate		1-60w Med.	AU, MB	•	•	•	•	•

For posts and pier mounts, see pages 406-407.

AVAILABLE OPTIONS

TRAFALGAR™

Finish Mocha
 Glass Clear seeded
 Details Cast aluminum construction;
 distressed finish



1316 MO



1315 MO



1312 MO



1311 MO



1319 MO



1314 MO

TRAFALGAR

Mocha (MO)

ITEM	WIDTH/DIA.	HEIGHT	EXT.	TOP TO OUTLET	BACK PLATE/CANOPY	WIRE/CHAIN	BULBS	AVAILABLE FINISHES					
1311 MO	12" W	27½"			3" Dia. Post Fitter		3-40w Cand.	MB, MO	•				•
1312 MO	12" W	24¾"			5" Dia. Canopy	6', 5'	3-40w Cand.	MB, MO	•				•
1314 MO	8" W	17½"	10½"	7½"	6¾" W, 12½" H Back Plate		1-75w Med.	MB, MO	•				•
1315 MO	10" W	22"	13½"	9½"	8½" W, 15½" H Back Plate		3-40w Cand.	MB, MO	•				•
1316 MO	6" W	10"	7½"	5¼"	4½" W, 7" H Back Plate		1-60w Med.	MB, MO					
1319 MO	12" W	26½"	16"	11½"	10" W, 18¾" H Back Plate		3-40w Cand.	MB, MO	•				•

For posts and pier mounts, see pages 406-407.

AVAILABLE OPTIONS

TRAFALGAR™

Finish Museum Black
 Glass Clear seeded
 Details Cast aluminum construction;
 distressed finish



1312 MB



1315 MB



1316 MB



1314 MB







1319 MB



1311 MB

TRAFALGAR

Museum Black (MB)

ITEM	WIDTH/DIA.	HEIGHT	EXT.	TOP TO OUTLET	BACK PLATE/CANOPY	WIRE/CHAIN	BULBS	AVAILABLE FINISHES					
1311 MB	12" W	27½"			3" Dia. Post Fitter		3-40w Cand.	MB, MO	•				•
1312 MB	12" W	24¾"			5" Dia. Canopy	6', 5'	3-40w Cand.	MB, MO	•				•
1314 MB	8" W	17½"	10½"	7½"	6¾" W, 12½" H Back Plate		1-75w Med.	MB, MO	•				•
1315 MB	10" W	22"	13½"	9½"	8½" W, 15½" H Back Plate		3-40w Cand.	MB, MO	•				•
1316 MB	6" W	10"	7½"	5¼"	4½" W, 7" H Back Plate		1-60w Med.	MB, MO					
1319 MB	12" W	26½"	16"	11½"	10" W, 18¾" H Back Plate		3-40w Cand.	MB, MO	•				•

For posts and pier mounts, see pages 406-407.

AVAILABLE OPTIONS

WABASH™

Finish Mocha
Glass Clear beveled with etched glass corner panels
Details Solid aluminum construction; distressed finish; decorative chevron corner panel detailing



1331 MO



1335 MO



1332 MO



1334 MO



1336 MO

WABASH

Mocha (MO)

ITEM	WIDTH/DIA.	HEIGHT	EXT.	TOP TO OUTLET	BACK PLATE/CANOPY	WIRE/CHAIN	BULBS	AVAILABLE FINISHES					
1331 MO	11" W	23"			3" Dia. Post Fitter		3-40w Cand.	MB, MO					
1332 MO	11" W	17¾"			4½" Dia. Canopy	6', 5'	3-40w Cand.	MB, MO	•	•			•
1334 MO	8¼" W	13¾"	10"	4¼"	6" W, 9" H Back Plate		2-40w Cand.	MB, MO	•	•			•
1335 MO	11" W	18½"	13¾"	5¼"	7½" W, 11¾" H Back Plate		3-40w Cand.	MB, MO	•	•			•
1336 MO	6¼" W	10½"	7¾"	3½"	4½" W, 6¾" H Back Plate		1-60w Med.	MB, MO	•	•			•

For posts and pier mounts, see pages 406-407.

AVAILABLE OPTIONS

WABASH™

Finish Museum Black
Glass Clear beveled with etched glass corner panels
Details Solid aluminum construction; distressed finish; decorative chevron corner panel detailing



1332 MB



1335 MB



1331 MB



1336 MB



1334 MB

WABASH

Museum Black (MB)

ITEM	WIDTH/DIA.	HEIGHT	EXT.	TOP TO OUTLET	BACK PLATE/CANOPY	WIRE/CHAIN	BULBS	AVAILABLE FINISHES					
1331 MB	11" W	23"			3" Dia. Post Fitter		3-40w Cand.	MB, MO					
1332 MB	11" W	17¾"			4½" Dia. Canopy	6', 5'	3-40w Cand.	MB, MO	•	•	•		
1334 MB	8½" W	13¾"	10"	4¼"	6" W, 9" H Back Plate		2-40w Cand.	MB, MO	•	•	•		
1335 MB	11" W	18½"	13¾"	5¼"	7½" W, 11¾" H Back Plate		3-40w Cand.	MB, MO	•	•	•		
1336 MB	6¼" W	10½"	7¾"	3½"	4½" W, 6¾" H Back Plate		1-60w Med.	MB, MO	•	•	•		

For posts and pier mounts, see pages 406-407.

AVAILABLE OPTIONS

CHERRY CREEK™

Finish Vintage Black
Glass White linen
Details Cast aluminum construction;
updated Arts and Crafts design



1275 VK

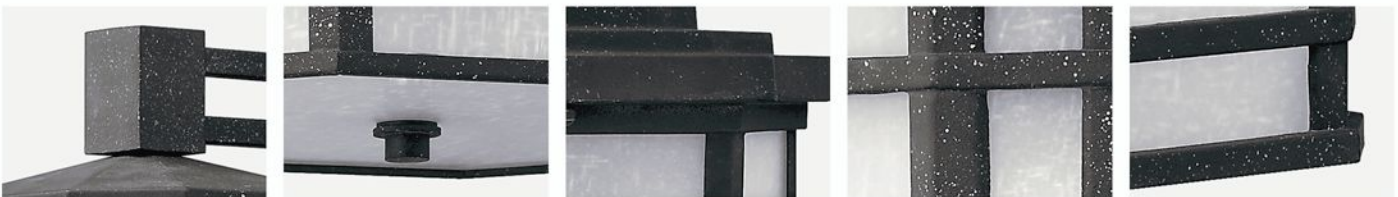



1272 VK



1270 VK



1273 VK







1274 VK



1271 VK

CHERRY CREEK

Vintage Black (VK)

ITEM	WIDTH/DIA.	HEIGHT	EXT.	TOP TO OUTLET	BACK PLATE/CANOPY	WIRE/CHAIN	BULBS	AVAILABLE FINISHES					
1270 VK	6½" W	11"	7¼"	4¼"	4½" W, 7" H Back Plate		1-60w Med.	VK	•	•	•	•	•
1271 VK	12" W	22¼"			3" Dia. Post Fitter		1-100w Med.	VK	•				
1272 VK	12" W	20¾"			5½" Dia. Canopy	6', 5'	1-100w Med.	VK	•	•	•	•	•
1273 VK	12" W	7¼"					2-60w Med.	VK					
1274 VK	8½" W	15¼"	9¼"	5"	4½" W, 10" H Back Plate		1-75w Med.	VK	•	•	•	•	•
1275 VK	12" W	20½"	12¾"	6½"	5" W, 13" H Back Plate		1-100w Med.	VK	•	•	•	•	•

For posts and pier mounts, see pages 406-407.

AVAILABLE OPTIONS

PARKSIDE™

Finish Oil Rubbed Bronze
Glass Honey art
Details Solid aluminum construction;
asymmetrical detailing



2005 OZ





2002 OZ



2000 OZ



2004 OZ



2001 OZ

PARKSIDE

Oil Rubbed Bronze (OZ)

ITEM	WIDTH/DIA.	HEIGHT	EXT.	TOP TO OUTLET	BACK PLATE/CANOPY	WIRE/CHAIN	BULBS	AVAILABLE FINISHES					
2000 OZ	7" W	12"	8½"	5"	4½" W, 10" H Back Plate		1-100w Med.	OZ	•	•	•	•	•
2001 OZ	9" Dia.	20½"			3" Dia. Post Fitter		1-100w Med.	OZ	•				
2002 OZ	9" Dia.	20¼"			5¾" Square Canopy		1-100w Med.	OZ	•	•	•	•	•
2004 OZ	7" W	14¾"	9"	7½"	4½" W, 10" H Back Plate		1-100w Med.	OZ	•	•	•	•	•
2005 OZ	9" W	18¾"	11¼"	9½"	4½" W, 12" H Back Plate		1-100w Med.	OZ	•	•	•	•	•

For posts and pier mounts, see pages 406-407.

AVAILABLE OPTIONS

TAHOE™

- Finish** Regency Bronze
- Glass** Clear seedy waterglass with copper foil art glass accents
- Details** Cast aluminum construction; classic Arts and Crafts design



2244 RB





2242 RB



2240 RB



2243 RB







2246 RB



2241 RB

TAHOE

Regency Bronze (RB)

ITEM	WIDTH/DIA.	HEIGHT	EXT.	TOP TO OUTLET	BACK PLATE/CANOPY	WIRE/CHAIN	STEMS INCLUDED	BULBS	AVAILABLE FINISHES					
2240 RB	8½" W	17"	11"	9¾"	4½" W, 14" H Back Plate			3-40w Cand.	RB					
2241 RB	12" W	22¼"			3" Dia. Post Fitter			4-40w Cand.	RB					
2242 RB	12" W	22½"			5½" Dia. Canopy	6', 5'		4-40w Cand.	RB					
2243 RB	9½" W	6"						2-60w Med.	RB					
2244 RB	12" W	22½"	14¾"	13¾"	4½" W, 18" H Back Plate			4-40w Cand.	RB					
2246 RB	6½" W	12"	9"	7½"	4½" W, 9¼" H Back Plate			1-60w Med.	RB					

For posts and pier mounts, see pages 406-407.

AVAILABLE OPTIONS

INNSBRUCK™

Finish Regency Bronze
Glass Copper foil art
Details Cast aluminum construction;
brass channel Tiffany style glass



1865 RB





1862 RB

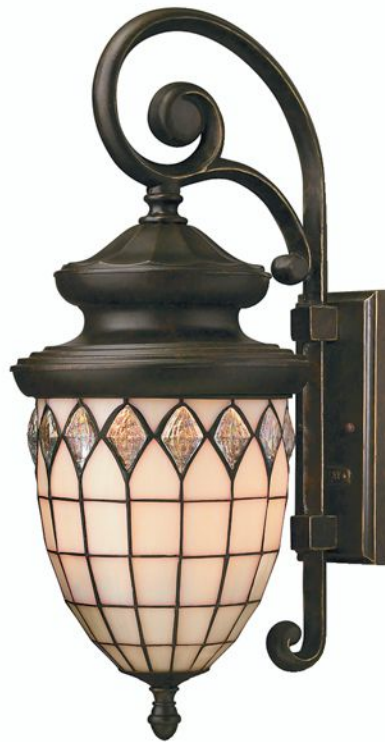

1864 RB



1860 RB



1861 RB

INNSBRUCK

Regency Bronze (RB)

ITEM	WIDTH/DIA.	HEIGHT	EXT.	TOP TO OUTLET	BACK PLATE/CANOPY	WIRE/CHAIN	BULBS	AVAILABLE FINISHES					
1860 RB	7" W	17½"	9¼"	10¼"	4½" W, 7¼" H Back Plate		1-60w Med.	RB					
1861 RB	12" Dia.	24¼"			3" Dia. Post Fitter		1-75w Med.	RB					
1862 RB	12" Dia.	23½"			5½" Dia. Canopy	6', 5'	4-40w Cand.	RB					
1864 RB	9¾" W	24"	12½"	13¾"	4½" W, 9¼" H Back Plate		3-40w Cand.	RB					
1865 RB	12"	29"	15"	14½"	4½" W, 9¼" H Back Plate		4-40w Cand.	RB					

For posts and pier mounts, see pages 406-407.

AVAILABLE OPTIONS

OXFORD™

Finish Midnight Bronze
Glass Clear optic
Details Solid aluminum construction;
bead detailing



1245 MN





1242 MN



1240 MN



1243 MN







1244 MN



1241 MN

OXFORD

Midnight Bronze (MN)

ITEM	WIDTH/DIA.	HEIGHT	EXT.	TOP TO OUTLET	BACK PLATE/CANOPY	WIRE/CHAIN	BULBS	AVAILABLE FINISHES	    
1240 MN	7" W	17¼"	9"	10"	4¾" W, 9" H Back Plate		1-60w Med.	MN	
1241 MN	12" Dia.	28½"			3" Dia. Post Fitter		3-40w Cand.	MN	
1242 MN	12" Dia.	27½"			6¾" Dia. Canopy	6', 5'	3-40w Cand.	MN	
1243 MN	16¾" Dia.	7½"					2-60w Med.	MN	
1244 MN	9¾" W	23½"	12¼"	12½"	4¾" W, 9" H Back Plate		3-40w Cand.	MN	
1245 MN	12" W	28½"	15"	16"	4¾" W, 16" H Back Plate		3-40w Cand.	MN	

For posts and pier mounts, see pages 406-407.

AVAILABLE OPTIONS

TRELLIS™

Finish Regency Bronze
Glass Clear seeded
Details Solid aluminum construction;
hanging wall bracket design



1438 RB





1432 RB



1434 RB



1430 RB







1435 RB



1431 RB

TRELLIS

Regency Bronze (RB)

ITEM	WIDTH/DIA.	HEIGHT	EXT.	TOP TO OUTLET	BACK PLATE/CANOPY	WIRE/CHAIN	BULBS	AVAILABLE FINISHES					
1430 RB	7" W	15¼"	11¼"	6"	4½" W, 7" H Back Plate		1-100w Med.	RB					
1431 RB	11" W	21"			3" Dia. Post Fitter		3-60w Cand.	RB					
1432 RB	11" W	23¾"			4½" Square Canopy	6', 5'	3-60w Cand.	RB					
1434 RB	9" W	19¾"	14¼"	8"	4½" W, 10" H Back Plate		3-60w Cand.	RB					
1435 RB	11" W	22¼"	16¼"	8"	4½" W, 10" H Back Plate		4-60w Cand.	RB					
1438 RB	13" W	26¼"	19"	9½"	5" W, 13" H Back Plate		4-60w Cand.	RB					

For posts and pier mounts, see pages 406-407.

AVAILABLE OPTIONS

LUCERNE™

Finish Copper Bronze
Glass Clear bent panels
Details Solid brass construction;
decorative cast detailing



2315 CB





2312 CB



2314 CB



2313 CB



2316 CB



2310 CB







2317 CB



2311 CB

LUCERNE

Copper Bronze (CB)

ITEM	WIDTH/DIA.	HEIGHT	EXT.	TOP TO OUTLET	BACK PLATE/CANOPY	WIRE/CHAIN	BULBS	AVAILABLE FINISHES					
2310 CB	8½" W	15"	10½"	3½"	4½" W, 7½" H Back Plate		2-40w Cand.	CB	•	•			
2311 CB	13¼" Dia.	26½"			3" Dia. Post Fitter		4-40w Cand.	CB					
2312 CB	13¼" Dia.	26½"			5" Dia. Canopy	6', 5'	4-40w Cand.	CB	•	•			
2313 CB	12½" Dia.	7¼"					2-60w Med.	CB					
2314 CB	10½" W	24½"	13¾"	11¾"	5" W, 16" H Back Plate		3-40w Cand.	CB	•	•			
2315 CB	13¼" W	30"	17¼"	13½"	5" W, 16½" H Back Plate		4-40w Cand.	CB	•	•			
2316 CB	6" W	11¼"	7¼"	3½"	5" W, 7" H Back Plate		1-60w Med.	CB	•	•			
2317 CB	10½" Dia.	22¼"			3" Dia. Post Fitter		3-40w Cand.	CB					

For posts and pier mounts, see pages 406-407.

AVAILABLE OPTIONS

MONTICELLO™

- Finish Copper Bronze
- Glass Clear bent, beveled and bound panels
- Details Solid brass construction
- See also Monticello landscape, page 410







2336 CB





MONTICELLO

Copper Bronze (CB)

ITEM	WIDTH/DIA.	HEIGHT	EXT.	TOP TO OUTLET	BACK PLATE/CANOPY	WIRE/CHAIN	BULBS	AVAILABLE FINISHES				
2330 CB	9" W	15¼"	9¾"	5"	5" W, 7" H Back Plate		1-60w Med.	CB	•	•		
2331 CB	13" Dia.	21¾"			3" Dia. Post Fitter		3-40w Cand.	CB				
2332 CB	13" Dia.	20¼"			5" Dia. Canopy	6', 5'	3-40w Cand.	CB	•	•		
2334 CB	11" W	19¼"	12½"	6"	4½" W, 9¼" H Back Plate		3-40w Cand.	CB	•	•		
2335 CB	13" W	20½"	13¾"	6¼"	5" W, 9¼" H Back Plate		3-40w Cand.	CB	•	•		
2336 CB	16½" W	26½"	15¾"	8"	4½" W, 16" H Back Plate		4-40w Cand.	CB	•	•		
2337 CB	16½" Dia.	27"			3" Dia. Post Fitter		4-40w Cand.	CB				
2443 CB	15¾" Dia.	9"			12" Dia. Canopy		2-60w Med.	CB, MB				

For posts and pier mounts, see pages 406-407.

AVAILABLE OPTIONS

AUGUSTA™

- Finish** Copper Bronze
- Glass** Clear bent, beveled and bound panels
- Details** Solid brass construction; removable scrolls



2456 CB





2452 CB



2454 CB



2443 CB







2450 CB



2451 CB

AUGUSTA

Copper Bronze (CB)

ITEM	WIDTH/DIA.	HEIGHT	EXT.	TOP TO OUTLET	BACK PLATE/CANOPY	WIRE/CHAIN	BULBS	AVAILABLE FINISHES				
2443 CB	15¾" Dia.	9"			12" Dia. Canopy		2-60w Med.	CB, MB				
2450 CB	9" W	15½", 12½"	8½"	7½", 4½"	4½" W, 6½" H Back Plate		1-60w Med.	CB				
2451 CB	13" Dia.	23¾"			3" Dia. Post Fitter		3-40w Cand.	CB				
2452 CB	13" Dia.	27½"			5" Dia. Canopy	6', 5'	3-40w Cand.	CB				
2454 CB	11" W	27", 22½"	10½"	18¼", 13¾"	4½" W, 17" H Back Plate		3-40w Cand.	CB				
2456 CB	16" W	38¾", 31¾"	14½"	26¼", 19½"	5" W, 24" H Back Plate		4-40w Cand.	CB				

*Measurement without removable scroll. For posts and pier mounts, see pages 406-407.

AVAILABLE OPTIONS

SAN CLEMENTE™

Finish Copper Bronze
Glass Clear bent, beveled and bound
Details Cast aluminum and brass construction;
cast ornamental detailing







2446 CB





SAN CLEMENTE

Copper Bronze (CB)

ITEM	WIDTH/DIA.	HEIGHT	EXT.	TOP TO OUTLET	BACK PLATE/CANOPY	WIRE/CHAIN	BULBS	AVAILABLE FINISHES					
2440 CB	9½" W	14½"	9½"	5½"	4½" W, 6½" H Back Plate		1-60w Med.	CB, MB	•	•			
2441 CB	14" Dia.	23"			3" Dia. Post Fitter		3-40w Cand.	CB, MB					
2442 CB	14" Dia.	22"			5" Dia. Canopy	6', 5'	3-40w Cand.	CB, MB	•	•			
2443 CB	15¾" Dia.	9"					2-60w Med.	CB, MB					
2444 CB	12" W	21"	12½"	6½"	4½" W, 9" H Back Plate		3-40w Cand.	CB, MB	•	•			
2445 CB	14" W	21½"	13"	6"	4½" W, 9" H Back Plate		3-40w Cand.	CB	•	•			
2446 CB	18" W	28"	16"	8¼"	5" W, 14" H Back Plate		4-40w Cand.	CB, MB	•	•			
2447 CB	15½" Dia.	26½"			3" Dia. Post Fitter		3-40w Cand.	CB, MB					

For posts and pier mounts, see pages 406-407.

AVAILABLE OPTIONS

SAN CLEMENTE™

Finish Museum Black
Glass Clear bent, beveled and bound
Details Cast aluminum and brass construction;
cast ornamental detailing



2446 MB





2442 MB



2444 MB



2443 MB



2440 MB







2441 MB



2447 MB

SAN CLEMENTE

Museum Black (MB)

ITEM	WIDTH/DIA.	HEIGHT	EXT.	TOP TO OUTLET	BACK PLATE/CANOPY	WIRE/CHAIN	BULBS	AVAILABLE FINISHES					
2440 MB	9½" W	14½"	9½"	5½"	4½" W, 6½" H Back Plate		1-60w Med.	CB, MB	•	•			
2441 MB	14" Dia.	23"			3" Dia. Post Fitter		3-40w Cand.	CB, MB					
2442 MB	14" Dia.	22"			5" Dia. Canopy	6', 5'	3-40w Cand.	CB, MB	•	•			
2443 MB	15¾" Dia.	9"					2-60w Med.	CB, MB					
2444 MB	12" W	21"	12½"	6½"	4½" W, 9" H Back Plate		3-40w Cand.	CB, MB	•	•			
2446 MB	18" W	28"	16"	8¼"	5" W, 14" H Back Plate		4-40w Cand.	CB, MB	•	•			
2447 MB	15½" Dia.	26½"			3" Dia. Post Fitter		3-40w Cand.	CB, MB					

For posts and pier mounts, see pages 406-407. For posts and pier mounts, see pages 406-407.

AVAILABLE OPTIONS

CLIFTON BEACH™

Finish Antique Copper
Glass Clear seedy bound
Details Solid brass construction



2268 AP





2262 AP



2265 AP



2260 AP







2263 AP



2261 AP

CLIFTON BEACH

Antique Copper (AP)

ITEM	WIDTH/DIA.	HEIGHT	EXT.	TOP TO OUTLET	BACK PLATE/CANOPY	WIRE/CHAIN	BULBS	AVAILABLE FINISHES					
2260 AP	6¾" W	11"	6½"	4½"	4¾" W, 5½" H Back Plate		1-60w Med.	AP					
2261 AP	12½" Dia.	24"			3" Dia. Post Fitter		3-40w Cand.	AP					
2262 AP	10½" Dia.	19"			5" Dia. Canopy	6', 5'	3-40w Cand.	AP			•	•	
2263 AP	9½" W	14¾"	8¾"	6"	4¾" W, 7" H Back Plate		1-75w Med.	AP			•	•	
2265 AP	9½" W	17¾"	9"	11¼"	4¾" W, 12¾" H Back Plate		2-40w Cand.	AP					
2268 AP	12½" W	25½"	11½"	16½"	4¾" W, 18" H Back Plate		3-40w Cand.	AP					

For posts and pier mounts, see pages 406-407.

AVAILABLE OPTIONS

CLIFTON PARK™

Finish Copper Bronze
 Glass Clear beveled and bound
 Details Solid brass construction



2420 CB



2426 CB



2428 CB



2423 CB



2406 CB

CLIFTON PARK

Copper Bronze (CB)

ITEM	WIDTH/DIA.	HEIGHT	EXT.	TOP TO OUTLET	BACK PLATE/CANOPY	WIRE/CHAIN	BULBS	AVAILABLE FINISHES					
2406 CB	17½" W	36"	16"	21¾"	4¾" W, 27¼" H Back Plate		4-40w Cand.	CB					
2420 CB	6¾" W	10¾"	6½"	4½"	4¾" W, 5½" H Back Plate		1-60w Med.	CB					
2423 CB	9¾" W	14¾"	8¾"	6¼"	4¾" W, 7" H Back Plate		1-75w Med.	CB			•	•	
2426 CB	10½" W	21½"	10"	14"	4¾" W, 14¼" H Back Plate		3-40w Cand.	CB					
2428 CB	12½" W	20½"	11½"	15¼"	4¾" W, 18¼" H Back Plate		3-40w Cand.	CB					

AVAILABLE OPTIONS



2422 CB



2425 CB



2429 CB



2424 CB







2421 CB



2407 CB

CLIFTON PARK

Copper Bronze (CB)

ITEM	WIDTH/DIA.	HEIGHT	EXT.	TOP TO OUTLET	BACK PLATE/CANOPY	WIRE/CHAIN	BULBS	AVAILABLE FINISHES					
2407 CB	17½" Dia.	26½"			3" Dia. Post Fitter		4-40w Cand.	CB					
2421 CB	12½" Dia.	23¾"			3" Dia. Post Fitter		3-40w Cand.	CB					
2422 CB	10½" Dia.	19"			5" Dia. Canopy	6', 5'	3-40w Cand.	CB					
2424 CB	10½" W	18½"	10"	7"	4¾" W, 7" H Back Plate		3-40w Cand.	CB			•	•	
2425 CB	9¼" W	17¾"	8¾"	11¼"	4¾" W, 12¾" H Back Plate		2-40w Cand.	CB					
2429 CB	12½" Dia.	6¾"					2-60w Med.	CB					

For posts and pier mounts, see pages 406-407.

AVAILABLE OPTIONS

REVERE™

Finish Sienna
Glass Clear seedy
Details Solid brass construction; hip roof;
glass candle sleeves



1185 SN





1182 SN



1184 SN



1180 SN



1181 SN

REVERE

Sienna (SN)

ITEM	WIDTH/DIA.	HEIGHT	EXT.	TOP TO OUTLET	BACK PLATE/CANOPY	WIRE/CHAIN	BULBS	AVAILABLE FINISHES	    
1180 SN	4½" W	17½"	5½"	10¼"	4½" W, 11" H Back Plate		1-60w Cand.	SN	
1181 SN	7" W	22¼"			3" Dia. Post Fitter		3-60w Cand.	SN	
1182 SN	7" W	20½"			5" Dia. Canopy	6', 5'	3-60w Cand.	SN	
1184 SN	7" W	21¾"	7¼"	12¼"	4½" W, 11" H Back Plate		2-60w Cand.	SN	
1185 SN	7" W	21¾"	10"	12¼"	4½" W, 11" H Back Plate		3-60w Cand.	SN	

For posts and pier mounts, see pages 406-407.

AVAILABLE OPTIONS

WESTWINDS™

Finish Sienna
Glass Clear waterglass panels
Details Solid brass construction;
stamped filigree detailing



2996 SN



2990 SN



2989 SN



2995 SN





2992 SN



2994 SN
(flush wall mount)



2999 SN







2993 SN
(flush wall mount)



2991 SN

WESTWINDS

Sienna (SN)

ITEM	WIDTH/DIA.	HEIGHT	EXT.	TOP TO OUTLET	BACK PLATE/CANOPY	WIRE/CHAIN	BULBS	AVAILABLE FINISHES	    
2989 SN	6" W	11¾"	6½"	7½"	4¾" W, 5½" H Back Plate		1-60w Med.	SN	• •
2990 SN	8½" W	19"	9½"	13½"	4½" W, 9½" H Back Plate		2-40w Cand.	SN	• •
2991 SN	13" Dia.	20½"			3" Dia. Post Fitter		3-40w Cand.	SN	
2992 SN	10½" Dia.	16¾"			5½" Dia. Canopy	6', 5'	3-40w Cand.	SN	
2993 SN	8" W	10"	6¼"	6"	4½" W, 8" H Back Plate		1-75w Med.	SN	
2994 SN	10½" W	12½"	6"	8"	7¾" W, 9½" H Back Plate		1-40w Cand.	SN	
2995 SN	10½" W	22½"	12½"	17½"	4½" W, 9½" H Back Plate		3-40w Cand.	SN	• •
2996 SN	12¾" W	27½"	14¼"	21½"	4¾" W, 12¼" H Back Plate		3-40w Cand.	SN	• •
2999 SN	13½" Dia.	7½"					3-40w Cand.	SN	

For posts and pier mounts, see pages 406-407.

AVAILABLE OPTIONS

NANTUCKET™

- Finish Aged Brass
- Glass Clear seedy panels
- Details Solid brass construction;
classic New England design



2374 AS





2372 AS



2370 AS



2376 AS



2371 AS

NANTUCKET

Aged Brass (AS)

ITEM	WIDTH/DIA.	HEIGHT	EXT.	TOP TO OUTLET	BACK PLATE/CANOPY	WIRE/CHAIN	BULBS	AVAILABLE FINISHES	    
2370 AS	5½" W	13½"	5½"	8¾"	5½" W, 7" H Back Plate		1-75w Med.	AS	
2371 AS	7½" W	20¾"			3" Dia. Post Fitter		3-60w Cand.	AS	
2372 AS	5½" W	14½"			5" Dia. Canopy	6', 5'	2-40w Cand.	AS	
2374 AS	7½" W	17"	6¾"	11¼"	7½" W, 8¼" H Back Plate		2-60w Cand.	AS	
2376 AS	4½" W	9¾"	4½"	7"	4½" W, 5" H Back Plate		1-60w Med.	AS	

For posts and pier mounts, see pages 406-407.

AVAILABLE OPTIONS

CAPE COD™

Finish Sienna Bronze
Glass Clear seedy
Details Solid brass construction;
classic onion lantern design



2204 SZ



2200 SZ



2205 SZ





2202 SZ



2206 SZ



2203 SZ



2207 SZ



2201 SZ

CAPE COD

Sienna Bronze (SZ)

ITEM	WIDTH/DIA.	HEIGHT	EXT.	TOP TO OUTLET	BACK PLATE/CANOPY	WIRE/CHAIN	BULBS	AVAILABLE FINISHES					
2200 SZ	8¾" W	18"	10¼"	11½"	4¼" W, 5½" H Back Plate		1-75w Med.	SZ		•	•		
2201 SZ	14" Dia.	23¾"			3" Dia. Post Fitter		4-40w Cand.	SZ					
2202 SZ	11" Dia.	18"			5" Dia. Canopy	6', 5'	1-100w Med.	SZ		•	•		
2203 SZ	7" Dia.	9", 9¾"			5" Dia. Canopy	6', 5'	1-60w Med.	SZ					
2204 SZ	11" W	23¾"	13"	16"	4½" W, 9½" H Back Plate		1-100w Med.	SZ		•	•		
2205 SZ	14" W	26¾"	15"	17"	4½" W, 10" H Back Plate		1-100w Med.	SZ		•	•		
2206 SZ	7¼" W	14"	8"	9¼"	4¼" W, 5½" H Back Plate		1-60w Med.	SZ					
2207 SZ	11¼" Dia.	21¼"			3" Dia. Post Fitter		3-40w Cand.	SZ					

*Height when hung with chain. For posts and pier mounts, see pages 406-407.

AVAILABLE OPTIONS

FREEPORT™

Finish Olde Penny
Glass Etched seedy
Details Cast aluminum construction;
finish features hand-rubbed accents



1805 OP





1802 OP



1804 OP



1800 OP



1801 OP

FREEPORT

Olde Penny (OP)

ITEM	WIDTH/DIA.	HEIGHT	EXT.	TOP TO OUTLET	BACK PLATE/CANOPY	WIRE/CHAIN	BULBS	AVAILABLE FINISHES					
1800 OP	6" W	9¼"	7"	2½"	4½" W, 6" H Back Plate		1-75w Med.	OP, OZ	•	•	•		
1801 OP	10" Dia.	20¼"			3" Dia. Post Fitter		1-100w Med.	OP, OZ	•				
1802 OP	10" Dia.	14"			4¼" Dia. Canopy	6', 5'	1-100w Med.	OP, OZ	•	•	•	•	
1804 OP	8" W	12¼"	9"	3"	5" W, 8" H Back Plate		1-100w Med.	OP, OZ	•	•	•	•	
1805 OP	10" W	15¼"	11¼"	3¼"	5¾" W, 9½" H Back Plate		1-100w Med.	OP, OZ	•	•	•	•	

AVAILABLE OPTIONS

For posts and pier mounts, see pages 406-407.

FREEPORT™

Finish Oil Rubbed Bronze
Glass Clear seeded
Details Cast aluminum construction;
finish features hand-rubbed accents



1805 OZ





1802 OZ



1804 OZ



1800 OZ



1801 OZ

FREEPORT

Oil Rubbed Bronze (OZ)

ITEM	WIDTH/DIA.	HEIGHT	EXT.	TOP TO OUTLET	BACK PLATE/CANOPY	WIRE/CHAIN	BULBS	AVAILABLE FINISHES					
1800 OZ	6" W	9¼"	7"	2½"	4½" W, 6" H Back Plate		1-75w Med.	OP, OZ	•	•	•		
1801 OZ	10" Dia.	20¼"			3" Dia. Post Fitter		1-100w Med.	OP, OZ	•				
1802 OZ	10" Dia.	14"			4¼" Dia. Canopy	6', 5'	1-100w Med.	OP, OZ	•	•	•	•	•
1804 OZ	8" W	12¼"	9"	3"	5" W, 8" H Back Plate		1-100w Med.	OP, OZ	•	•	•	•	•
1805 OZ	10" W	15¼"	11¼"	3¼"	5¾" W, 9½" H Back Plate		1-100w Med.	OP, OZ	•	•	•	•	•

For posts and pier mounts, see pages 406-407.

AVAILABLE OPTIONS

WELLINGTON™

- Finish Regency Bronze
- Glass Light amber etched seeded copper foil panels
- Details Cast aluminum construction



2165 RB





2162 RB



2164 RB



2160 RB



2161 RB

WELLINGTON

Regency Bronze (RB)

ITEM	WIDTH/DIA.	HEIGHT	EXT.	TOP TO OUTLET	BACK PLATE/CANOPY	WIRE/CHAIN	BULBS	AVAILABLE FINISHES					
2160 RB	6" W	12½"	8"	5"	4½" W, 7" H Back Plate		1-60w Med.	RB	•	•	•		
2161 RB	10" W	21¼"			3" Dia. Post Fitter		1-100w Med.	RB	•				
2162 RB	10" W	19¼"			4½" Dia. Canopy	6', 5'	1-100w Med.	RB	•	•	•		
2164 RB	8" W	16¾"	10½"	6½"	4½" W, 9" H Back Plate		1-75w Med.	RB	•	•	•		
2165 RB	10" W	21"	12¾"	9"	4½" W, 12" H Back Plate		1-100w Med.	RB	•	•	•		

For posts and pier mounts, see pages 406-407.

AVAILABLE OPTIONS

BRYNMAR™

Finish Regency Bronze
Glass Amber linen
Details Cast aluminum construction;
decorative cast leaf detailing



1935 RB





1932 RB



1934 RB



1936 RB







1930 RB



1931 RB

BRYNMAR

Regency Bronze (RB)

ITEM	WIDTH/DIA.	HEIGHT	EXT.	TOP TO OUTLET	BACK PLATE/CANOPY	WIRE/CHAIN	BULBS	AVAILABLE FINISHES					
1930 RB	7" W	12¼"	8"	4"	4¾" W, 7" H Back Plate		1-60w Med.	RB	•	•	•		
1931 RB	12" W	27"			3" Dia. Post Fitter		1-100w Med.	RB	•				
1932 RB	12" W	27¾"			5½" Dia. Canopy	6', 5'	1-100w Med.	RB	•	•	•		
1934 RB	9½" W	20¼"	10½"	10¾"	5" W, 14" H Back Plate		1-75w Med.	RB	•				
1935 RB	12" W	27½"	12¾"	14"	5" W, 18" H Back Plate		1-100w Med.	RB	•				
1936 RB	5" W	8¾"	6"	3¼"	4¾" W, 6" H Back Plate		1-60w Med.	RB	•	•	•		

For posts and pier mounts, see pages 406-407.

AVAILABLE OPTIONS

ROWE PARK™

Finish Pearl Bronze
Glass Amber linen
Details Cast aluminum construction



2135 PZ





2132 PZ



2130 PZ



2134 PZ



2131 PZ

ROWE PARK

Pearl Bronze (PZ)

ITEM	WIDTH/DIA.	HEIGHT	EXT.	TOP TO OUTLET	BACK PLATE/CANOPY	WIRE/CHAIN	BULBS	AVAILABLE FINISHES					
2130 PZ	7 1/4" W	16 1/2"	9 1/2"	10 1/4"	4 1/2" W, 7 1/2" H Back Plate		1-60w Med.	PZ	•				•
2131 PZ	11 3/4" Dia.	26 1/4"			3" Dia. Post Fitter		1-100w Med.	PZ	•				•
2132 PZ	11 3/4" Dia.	21 3/4"			5 1/2" Dia. Canopy	6', 5'	1-100w Med.	PZ	•	•	•		•
2134 PZ	9 1/2" W	21 3/4"	12 1/4"	13 3/4"	4 1/2" W, 9" H Back Plate		1-100w Med.	PZ	•	•	•		•
2135 PZ	11 3/4" W	25 3/4"	14 3/4"	15 3/4"	4 1/2" W, 9" H Back Plate		1-100w Med.	PZ	•	•	•		•

AVAILABLE OPTIONS

For posts and pier mounts, see pages 406-407.

MONTREAL™

- Finish Aged Iron
- Glass Amber inside etched optic
- Details Cast aluminum construction; finish features antique copper highlights





































1735 AI





MONTREAL

Aged Iron (AI)

ITEM	WIDTH/DIA.	HEIGHT	EXT.	TOP TO OUTLET	BACK PLATE/CANOPY	WIRE/CHAIN	BULBS	AVAILABLE FINISHES					
1730 AI	7" W	20½"	10½"	9"	7" Dia. Back Plate		1-100w Med.	AI					
1731 AI	11" Dia.	27½"			3" Dia. Post Fitter		3-60w Cand.	AI					
1732 AI	11" Dia.	29"			7" Dia. Canopy	6', 5'	3-60w Cand.	AI					
1734 AI	8¾" W	25½"	12½"	10¾"	7" Dia. Back Plate		1-100w Med.	AI					
1735 AI	11" W	32"	16"	14"	7" Dia. Back Plate		3-60w Cand.	AI					
1736 AI	7" W	17¾"	9"	5¼"	7" Dia. Back Plate		1-75w Med.	AI					

For posts and pier mounts, see pages 406-407.

AVAILABLE OPTIONS

PLANTATION™

Finish Copper Bronze

Glass Clear optic

Details Solid brass and aluminum construction;
decorative cast detailing

See also Plantation chandeliers, pages 138-147

Plantation bath, pages 249-250

Plantation landscape, page 410



2229 CB





2222 CB



4881 CB



4102 CB



2226 CB







2221 CB



2227 CB

PLANTATION

Copper Bronze (CB)

ITEM	WIDTH/DIA.	HEIGHT	EXT.	TOP TO OUTLET	BACK PLATE/CANOPY	WIRE/CHAIN	BULBS	AVAILABLE FINISHES	    
2221 CB	10¼" Dia.	25¼"			3" Dia. Post Fitter		3-40w Cand.	CB	
2222 CB	12½" Dia.	28½"			6" Dia. Canopy	6', 5'	4-40w Cand.	BB, CB, PL, PZ	
2226 CB	6" W	14"	7"	5"	4¾" W, 8" H Back Plate		1-60w Med.	CB	
2227 CB	12½" Dia.	29½"			3" Dia. Post Fitter		4-40w Cand.	CB	
2229 CB	17½" W	49¼"	25¼"	24"	6" W, 36" H Back Plate		8-40w Cand.	CB	
4102 CB	12" Dia.	8"					2-60w Med.	BB, CB, PL, PZ	
4881 CB	16" Dia.	8¾"					3-60w Med.	BB, CB, PL, PZ	

For posts and pier mounts, see pages 406-407.

AVAILABLE OPTIONS



2225 CB



2224 CB







2220 CB



4882 CB  

PLANTATION

Copper Bronze (CB)

ITEM	WIDTH/DIA.	HEIGHT	EXT.	TOP TO OUTLET	BACK PLATE/CANOPY	WIRE/CHAIN	BULBS	AVAILABLE FINISHES					
2220 CB	8" W	21¼"	11"	11½"	5" W, 16" H Back Plate		1-75w Med.	CB					
2224 CB	10¼" W	28"	13½"	14½"	5" W, 20" H Back Plate		3-40w Cand.	CB					
2225 CB	12½" W	34"	17½"	17½"	5" W, 24" H Back Plate		4-40w Cand.	CB					
4882 CB	18" Dia.	40"			6" Dia. Canopy	12', 10'	6-40w Cand.	BB, CB, PZ					

For posts and pier mounts, see pages 412-413.

AVAILABLE OPTIONS

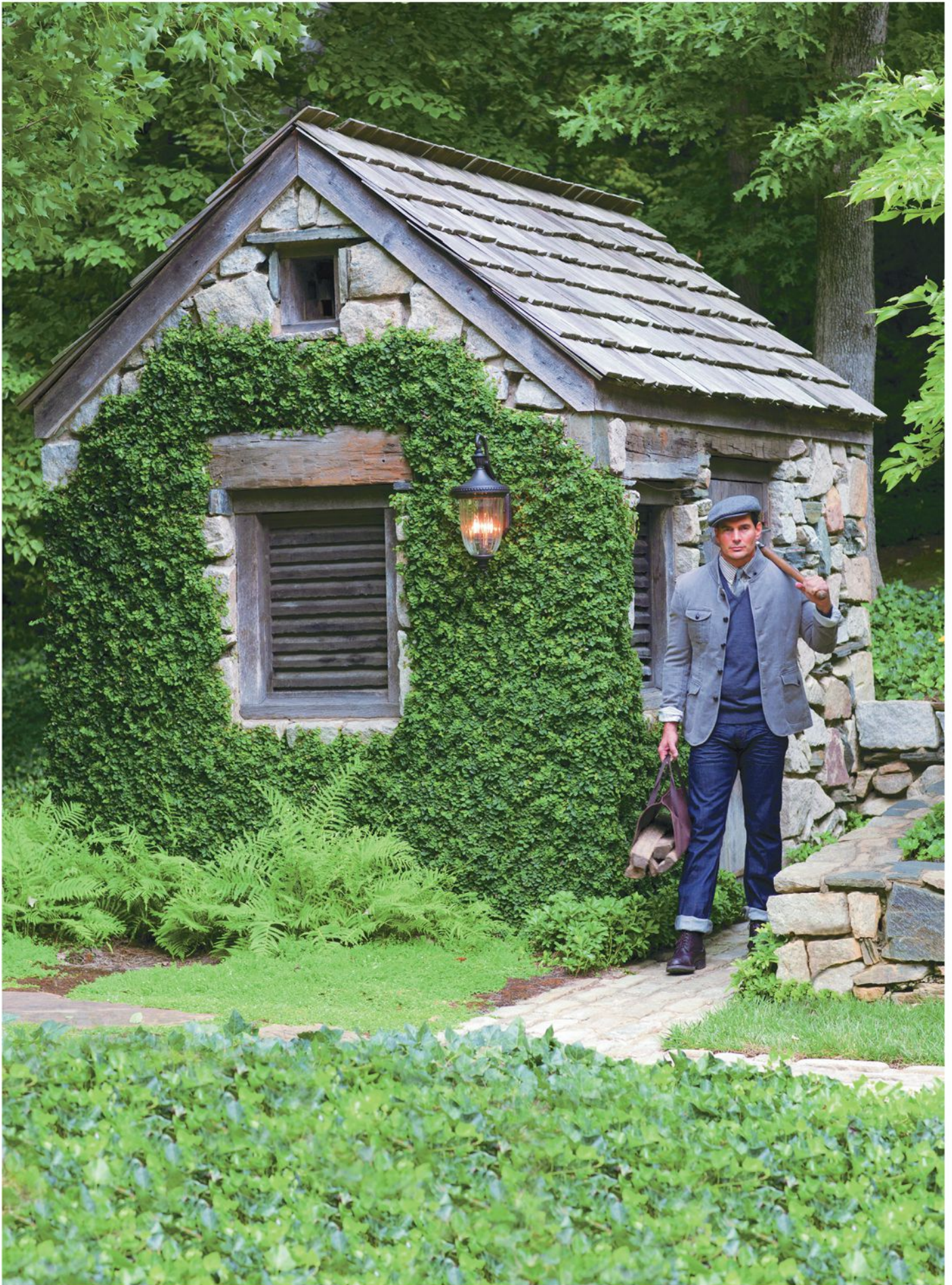

Fixture shown: Oxford 1245 MN, page 344

PLANTATION™

- Finish** Pearl Bronze
Glass Amber inside etched optic
Details Solid brass and aluminum construction;
decorative cast detailing
- See also** Plantation chandeliers, pages 138-147
Plantation bath, pages 249-250
Plantation landscape, page 410



2124 PZ





2122 PZ



2123 PZ



2128 PZ



2126 PZ







2120 PZ



2121 PZ

PLANTATION

Pearl Bronze (PZ)

ITEM	WIDTH/DIA.	HEIGHT	EXT.	TOP TO OUTLET	BACK PLATE/CANOPY	WIRE/CHAIN	BULBS	AVAILABLE FINISHES					
2120 PZ	8" W	21¼"	11"	11½"	5" W, 16" H Back Plate		1-75w Med.	PZ	•				
2121 PZ	10¼" Dia.	25½"			3" Dia. Post Fitter		1-100w Med.	PZ	•				
2122 PZ	12½" Dia.	28½"			6" Dia. Canopy	6', 5'	1-100w Med.	PZ	•				
2123 PZ	16" Dia.	8¾"					3-60w Med.	PZ	•				
2124 PZ	10¼" W	28"	13½"	14½"	5" W, 20" H Back Plate		1-75w Med.	PZ	•				
2126 PZ	6" W	14"	7"	5"	4¾" W, 8" H Back Plate		1-60w Med.	PZ	•				
2128 PZ	12" Dia.	8"					2-60w Med.	PZ	•				

For posts and pier mounts, see pages 406-407.

AVAILABLE OPTIONS

SORRENTO™

- Finish** Aged Iron
- Glass** Clear seedy (outer glass);
amber etched optic (inner glass)
- Details** Cast aluminum construction;
finish features hand-applied
copper highlights



1425 AI





1422 AI



1420 AI



1424 AI



1421 AI

SORRENTO

Aged Iron (AI)

ITEM	WIDTH/DIA.	HEIGHT	EXT.	TOP TO OUTLET	BACK PLATE/CANOPY	WIRE/CHAIN	BULBS	AVAILABLE FINISHES					
1420 AI	8" W	17"	11½"	10"	5" W, 9" H Back Plate		1-100w Med.	AI					
1421 AI	12¼" Dia.	28¾"			3" Dia. Post Fitter		1-100w Med.	AI					
1422 AI	12¼" Dia.	24"			5½" Dia. Canopy	6', 5'	1-100w Med.	AI					
1424 AI	9¾" W	20½"	13½"	12"	5" W, 9" H Back Plate		1-100w Med.	AI					
1425 AI	12¼" W	26¾"	16½"	16½"	5" W, 13" H Back Plate		1-100w Med.	AI					

For posts and pier mounts, see pages 406-407.

AVAILABLE OPTIONS

WINDSOR™

Finish River Rock
 Glass Clear waterglass
 Details Cast aluminum construction;
 decorative cast detailing



1894 RK



1899 RK



1929 RK



1890 RK



1895 RK

WINDSOR

River Rock (RK)

ITEM	WIDTH/DIA.	HEIGHT	EXT.	TOP TO OUTLET	BACK PLATE/CANOPY	WIRE/CHAIN	BULBS	AVAILABLE FINISHES					
1890 RK	7" W	12½"	8¼"	4¾"	5¾" W, 8" H Back Plate		1-75w Med.	RK					
1894 RK	9½" W	25½"	12"	13"	5¾" W, 12" H Back Plate		3-40w Cand.	RK					
1895 RK	12½" W	32"	15½"	16½"	6¼" W, 15" H Back Plate		4-40w Cand.	RK					
1899 RK	12½" W	25¾"	15½"	15¼"	6¼" W, 15" H Back Plate		4-40w Cand.	RK					
1929 RK	14" W	42"	17"	19½"	6¼" W, 17" H Back Plate		6-40w Cand.	RK					

AVAILABLE OPTIONS



1892 RK



1898 RK



1893 RK



1896 RK







1891 RK



1921 RK

WINDSOR

River Rock (RK)

ITEM	WIDTH/DIA.	HEIGHT	EXT.	TOP TO OUTLET	BACK PLATE/CANOPY	WIRE/CHAIN	BULBS	AVAILABLE FINISHES	    
1891 RK	12½" Dia.	30"			3" Dia. Post Fitter		4-40w Cand.	RK	
1892 RK	12½" Dia.	28½"			5½" Dia. Canopy	6', 5'	4-40w Cand.	RK	
1893 RK	12¾" Dia.	7"					2-60w Med.	RK	
1896 RK	5½" W	9¾"	6½"	3½"	4½" W, 7" H Back Plate		1-60w Med.	RK	
1898 RK	9½" W	20¾"	11¾"	12½"	5¾" W, 12" H Back Plate		3-40w Cand.	RK	
1921 RK	14¼" Dia.	34¾"			3" Dia. Post Fitter		6-40w Cand.	RK	

For posts and pier mounts, see pages 406-407.

AVAILABLE OPTIONS

FORUM™

Finish French Bronze
Glass Seedy waterglass panels
Details Cast aluminum construction;
decorative cast detailing



1944 FZ





1942 FZ



1940 FZ



1946 FZ



1941 FZ

FORUM

French Bronze (FZ)

ITEM	WIDTH/DIA.	HEIGHT	EXT.	TOP TO OUTLET	BACK PLATE/CANOPY	WIRE/CHAIN	BULBS	AVAILABLE FINISHES				
1940 FZ	7" W	21"	9¾"	9½"	5" W, 8" H Back Plate		1-75w Med.	FZ		•	•	
1941 FZ	9½" Dia.	23½"			3" Dia. Post Fitter		3-40w Cand.	FZ				
1942 FZ	9½" Dia.	25½"			5½" Dia. Canopy	6', 5'	3-40w Cand.	FZ				
1944 FZ	9½" W	27½"	12"	11"	5" W, 8" H Back Plate		3-40w Cand.	FZ				
1946 FZ	5½" W	12¾"	7½"	6"	4¾" W, 6½" H Back Plate		1-40w Med.	FZ		•	•	

For posts and pier mounts, see pages 406-407.

AVAILABLE OPTIONS

PEARL™

Finish Black
 Glass Translucent ribbed
 Details Cast aluminum construction



1364 BK



1362 BK



1361 BK



1366 BK



1360 BK

PEARL

Black (BK)

ITEM	WIDTH/DIA.	HEIGHT	EXT.	TOP TO OUTLET	BACK PLATE/CANOPY	WIRE/CHAIN	BULBS	AVAILABLE FINISHES					
1360 BK	7" W	11¾"	8½"	6½"	4¼" W, 5½" H Back Plate		1-60w Med.	BK	•	•	•		
1361 BK	9" W	16¾"			3" Dia. Post Fitter		1-100w Med.	BK	•				
1362 BK	9" W	15¼"			7" Dia. Canopy	6', 5'	1-100w Med.	BK	•	•	•		
1364 BK	9" W	15"	10½"	8½"	4¼" W, 7" H Back Plate		1-75w Med.	BK	•	•	•		
1366 BK	5½" W	8½"	6½"	3"	4¼" W, 5½" H Back Plate		1-60w Med.	BK	•				

For posts and pier mounts, see pages 406-407.

AVAILABLE OPTIONS

SENATOR™

Finish Black
 Glass Beveled and bound
 Details Cast aluminum and brass construction



2502 BK



2504 BK



2506 BK



2500 BK







2505 BK



2501 BK

SENATOR

Black (BK)

ITEM	WIDTH/DIA.	HEIGHT	EXT.	TOP TO OUTLET	BACK PLATE/CANOPY	WIRE/CHAIN	BULBS	AVAILABLE FINISHES	    
2500 BK	8½" W	14"	9"	6½"	5" W, 6¾" H Back Plate		1-60w Med.	BK	
2501 BK	13" Dia.	26½"			3" Dia. Post Fitter		3-40w Cand.	BK	
2502 BK	13" Dia.	25½"			5" Dia. Canopy	6', 5'	3-40w Cand.	BK	
2504 BK	11" W	21¾"	11½"	7¾"	5" W, 6¾" H Back Plate		3-40w Cand.	BK	
2505 BK	13" W	26"	15"	10"	6½" W, 8¾" H Back Plate		3-40w Cand.	BK	
2506 BK	6" W	9"	6½"	4¾"	5" W, 7" H Back Plate		1-60w Med.	BK	

For posts and pier mounts, see pages 406-407.

AVAILABLE OPTIONS

RALEY™

- Finish Museum Black
- Glass Clear waterglass panels
- Details Cast aluminum construction
- See also Raley landscape, page 410



1609 MB





1602 MB



1604 MB



1606 MB



1600 MB



1605 MB



1601 MB

RALEY

Museum Black (MB)

ITEM	WIDTH/DIA.	HEIGHT	EXT.	TOP TO OUTLET	BACK PLATE/CANOPY	WIRE/CHAIN	BULBS	AVAILABLE FINISHES					
1600 MB	7¼" W	16½"	9½"	10½"	4½" W, 7½" H Back Plate		1-60w Med.	MB	•				
1601 MB	11¾" Dia.	26¼"			3" Dia. Post Fitter		4-40w Cand.	MB	•				•
1602 MB	11¾" Dia.	27½"			5½" Dia. Canopy	6', 5'	4-40w Cand.	MB	•				•
1604 MB	9½" W	25½"	12¼"	14"	4½" W, 9½" H Back Plate		3-40w Cand.	MB	•				•
1605 MB	11¾" W	31¼"	14¾"	16¼"	4½" W, 9½" H Back Plate		4-40w Cand.	MB	•				•
1606 MB	5½" W	8¾"	6¼"	3½"	4½" W, 5½" H Back Plate		1-60w Med.	MB					
1609 MB	13" W	41¾"	17½"	20¾"	5½" W, 18" H Back Plate		4-40w Cand.	MB	•				•

For posts and pier mounts, see pages 406-407.

AVAILABLE OPTIONS

MANOR HOUSE™

Finish Black
Glass Clear beveled panels
Details Cast aluminum construction; Select-A-Lite options come standard with both candelabra and medium based sockets



MANOR HOUSE Black (BK)

ITEM	WIDTH/DIA.	HEIGHT	EXT.	TOP TO OUTLET	BACK PLATE/CANOPY	WIRE/CHAIN	BULBS	AVAILABLE FINISHES
1410 BK	9" W	25"	11"	13"	4½" W, 6¾" H Back Plate		1-60w Med. or 3-25w Cand.	BK
1440 BK	11" W	31"	12"	14"	5" W, 8¼" H Back Plate		1-75w Med. or 3-25w Cand.	BK
1445 BK	36" W Max.*	21"	12"	14"	5" W, 8¼" H Back Plate		1-75w Med. or 3-25w Cand.	BK
1470 BK	14" W	41"	16"	18"	5" W, 8¼" H Back Plate		1-100w Med. or 3-40w Cand.	BK
1810 BK	7" W	18"	7"	8"	4½" W, 5¾" H Back Plate		1-60w Med.	BK
1819 BK	7" W	12"	12"	8"	4½" W, 5¾" H Back Plate		1-60w Med.	BK

*Width with removable scroll.

AVAILABLE OPTIONS



MANOR HOUSE

Black (BK)

ITEM	WIDTH/DIA.	HEIGHT	EXT.	TOP TO OUTLET	BACK PLATE/CANOPY	WIRE/CHAIN	BULBS	AVAILABLE FINISHES
1412 BK	9" Dia.	15"			5½" Dia. Canopy	6', 5'	1-60w Med.	BK
1419 BK	9" W	18"	11"	13"	4½" W, 6¾" H Back Plate		1-60w Med.	BK
1441 BK	11" Dia.	22"			3" Dia. Post Fitter		1-75w Med. or 3-25w Cand.	BK
1449 BK	11" W	21"	12"	14"	5" W, 8¾" H Back Plate		1-75w Med. or 3-25w Cand.	BK
1471 BK	14" Dia.	27"			3" Dia. Post Fitter		1-100w Med. or 3-40w Cand.	BK
1472 BK	14" Dia.	24"			5" Dia. Canopy	6', 5'	3-40w Cand.	BK

For posts and pier mounts, see pages 406-407.

AVAILABLE OPTIONS

EDGEWATER™

Finish Black
Glass Clear seedy panels
Details Cast aluminum and brass construction



1675 BK





1672 BK



1670 BK



1674 BK



1683 BK



1676 BK



1671 BK



1677 BK

EDGEWATER

Black (BK)

ITEM	WIDTH/DIA.	HEIGHT	EXT.	TOP TO OUTLET	BACK PLATE/CANOPY	WIRE/CHAIN	BULBS	AVAILABLE FINISHES					
1670 BK	10" W	21"	9½"	14½"	5" W, 14" H Back Plate		3-40w Cand.	BK	•				•
1671 BK	10" Dia.	20½"			3" Dia. Post Fitter		3-40w Cand.	BK					
1672 BK	10" Dia.	18½"			5" Dia. Canopy	6', 5'	3-40w Cand.	BK	•				•
1674 BK	6½" W	11"	6½"	5½"	5" W, 7" H Back Plate		1-60w Med.	BK					
1675 BK	16" W	25½"	14½"	11"	5" W, 14" H Back Plate		4-40w Cand.	BK	•	•	•	•	
1676 BK	10" W	17½"	9½"	6½"	4½" W, 9" H Back Plate		3-40w Cand.	BK			•	•	
1677 BK	16" Dia.	27"			3" Dia. Post Fitter		4-40w Cand.	BK					
1683 BK	13" Dia.	9"					2-60w Med.	BK					

For posts and pier mounts, see pages 406-407.

AVAILABLE OPTIONS

CAMELOT™

Finish Black
Glass Clear beveled panels
Details Cast aluminum construction



1705 BK





1702 BK



1704 BK



1712 BK



1700 BK



1701 BK



1707 BK

CAMELOT

Black (BK)

ITEM	WIDTH/DIA.	HEIGHT	EXT.	TOP TO OUTLET	BACK PLATE/CANOPY	WIRE/CHAIN	BULBS	AVAILABLE FINISHES					
1700 BK	6½" W	15¾", 13¼"	7½"	10½"	4½" W, 7½" H Back Plate		1-75w Med.	BK					
1701 BK	8½" Dia.	19¾"			3" Dia. Post Fitter		3-40w Cand.	BK					
1702 BK	12" Dia.	25"			5" Dia. Canopy	6', 5'	3-40w Cand.	BK					
1704 BK	8½" W	26¾", 21½"	10"	17¼"	4½" W, 9" H Back Plate		3-40w Cand.	BK					
1705 BK	12" W	35", 29¼"	14¼"	22½"	5¼" W, 14" H Back Plate		3-40w Cand.	BK					
1707 BK	12" Dia.	25½"			3" Dia. Post Fitter		3-40w Cand.	BK					
1712 BK	11¾" Dia.	9¼"					4-30w G-16½"	BK					

*Measurement without removable scroll. For posts and pier mounts, see pages 406-407.

AVAILABLE OPTIONS

REGAL™

Finish Black Granite
Glass Clear seedy waterglass
Details Cast aluminum construction;
decorative stamped detailing

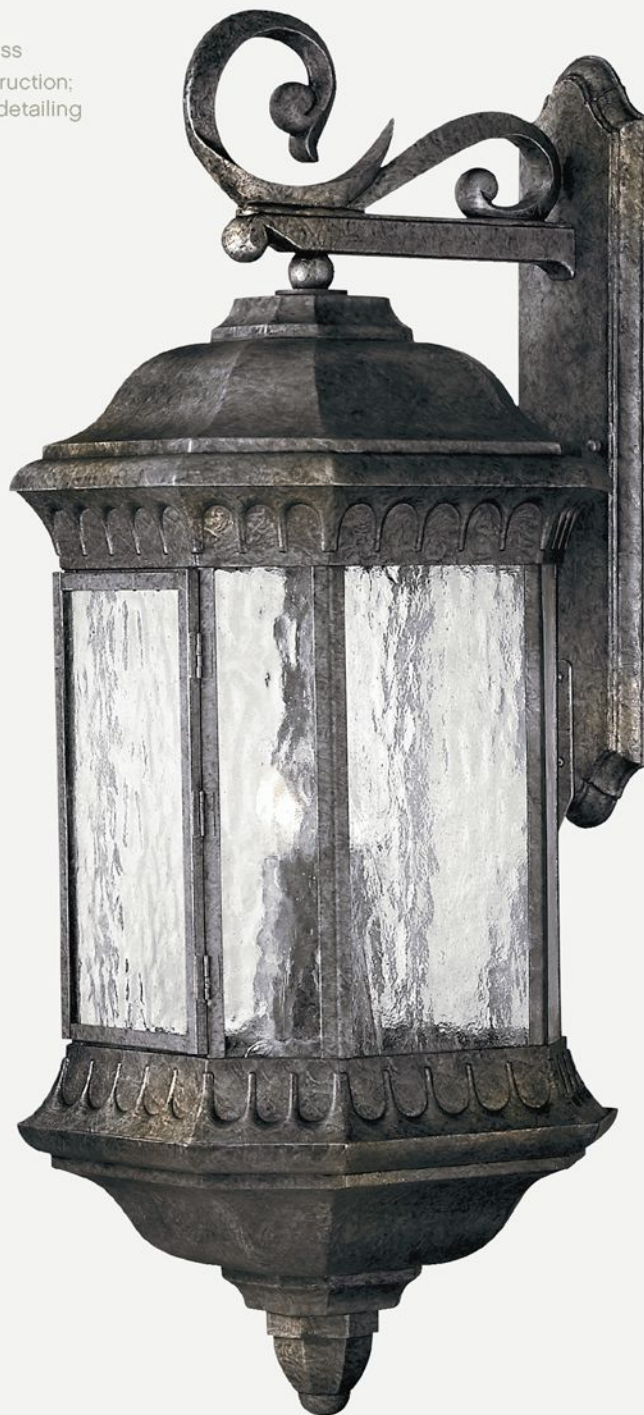

1726 BG





1722 BG



1725 BG



1720 BG



1713 BG



1729 BG







1721 BG



1727 BG

REGAL

Black Granite (BG)

ITEM	WIDTH/DIA.	HEIGHT	EXT.	TOP TO OUTLET	BACK PLATE/CANOPY	WIRE/CHAIN	BULBS	AVAILABLE FINISHES	    
1713 BG	11¾" Dia.	9"					4-40w G16½	BG	
1720 BG	6½" W	13"	8¼"	4¾"	4½" W, 9" H Back Plate		2-40w Cand.	BG	
1721 BG	8½" Dia.	22½"			3" Dia. Post Fitter		3-40w Cand.	BG	
1722 BG	8¾" Dia.	18"			5" Dia. Canopy	6', 5'	3-40w Cand.	BG	
1725 BG	8½" W	23½"	11¼"	7¼"	5" W, 14" H Back Plate		3-40w Cand.	BG	
1726 BG	12" W	32¼"	14¼"	10"	5" W, 18½" H Back Plate		4-40w Cand.	BG	
1727 BG	12" Dia.	30¼"			3" Dia. Post Fitter		4-40w Cand.	BG	
1729 BG	16¼" W	13"	8½"	5"	4½" W, 9" H Back Plate		4-40w Cand.	BG	

For posts and pier mounts, see pages 406-407.

AVAILABLE OPTIONS

POSTS

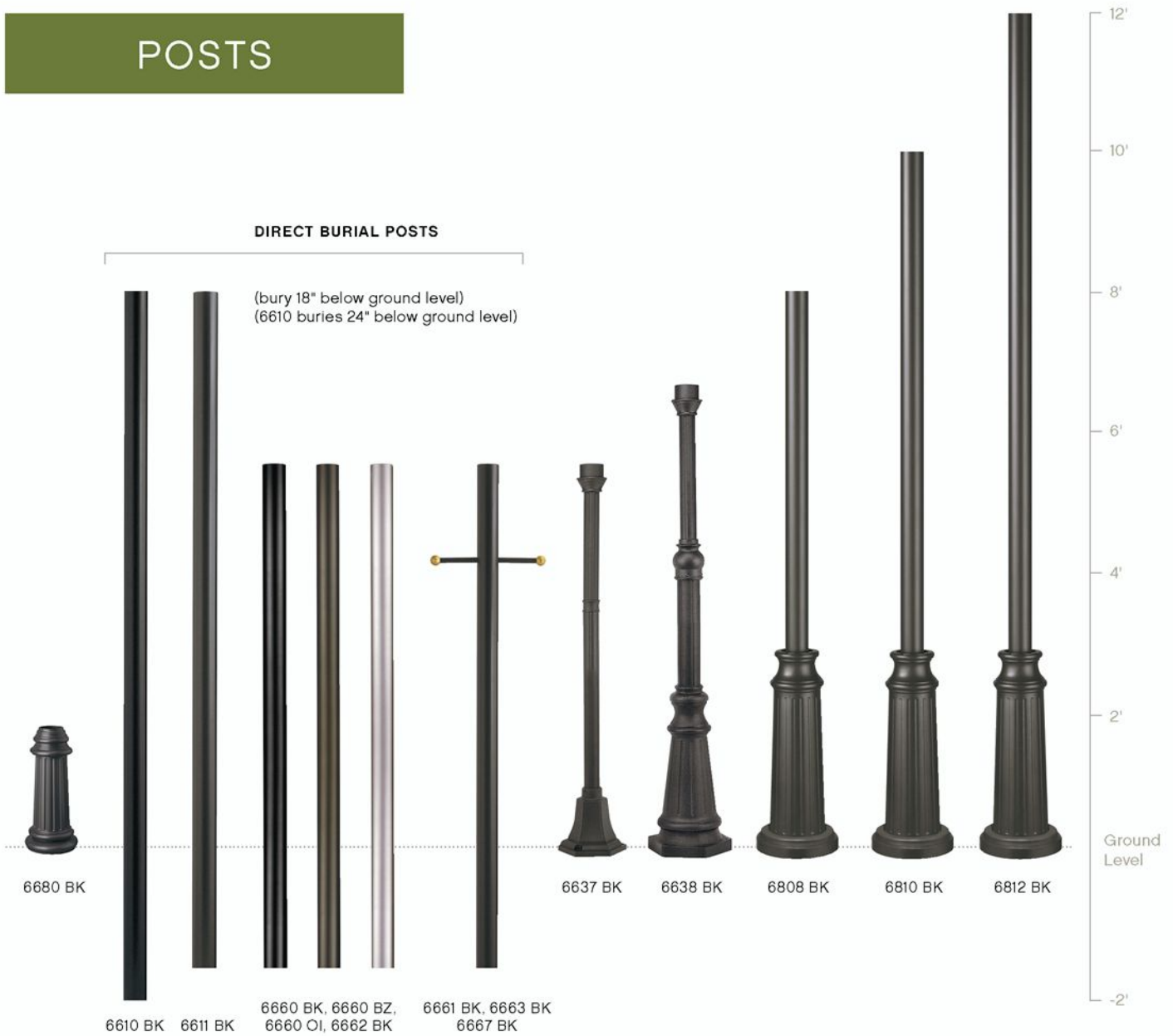

POSTS

ITEM	DIAMETER	HEIGHT	FITTER DIAMETER	WALL THICKNESS	CONSTRUCTION	ACCESSORIES INCLUDED / NOTES
6610 BK	3"	10'	3"	.072"	One-Piece Post, Aluminum	Ground Outlet, Photo Cell
6611 BK	3"	10'	3"	.072"	One-Piece Post, Aluminum	Photo Cell
6637 BK	3"	5½'	3"	.080"	Post, Cast Aluminum	Cast Aluminum Base
6638 BK	3"	6½'	3"	.080"	Post, Cast Aluminum	Cast Aluminum Base
6660 BK	3"	7'	3"	.050"	One-Piece Post, Aluminum	
6660 BZ	3"	7'	3"	.050"	One-Piece Post, Aluminum	
6660 OI	3"	7'	3"	.050"	One-Piece Post, Aluminum	
6661 BK	3"	7'	3"	.050"	One-Piece Post with Ladder Rest, Aluminum	
6662 BK	3"	7'	3"	.050"	One-Piece Post, Aluminum	Photo Cell
6663 BK	3"	7'	3"	.050"	One-Piece Post with Ladder Rest, Aluminum	Photo Cell
6667 BK	3"	7'	3"	.050"	One-Piece Post with Ladder Rest, Aluminum	Photo Cell and Ground Outlet
6680 BK	7¼"	18¼"	3"		Slip Base, Die Cast Aluminum	2-Piece, Used with Direct Burial Posts
6808 BK	10½"	8'	3"	.125"	Post, Cast Aluminum	Decorative Flange Bolt Cover
6810 BK	10½"	10'	3"	.125"	Post, Cast Aluminum	Decorative Flange Bolt Cover
6812 BK	10½"	12'	3"	.125"	Post, Cast Aluminum	Decorative Flange Bolt Cover

PIER MOUNTS



1301 BK



1304 BK



1305 BK



1307 BG



1307 BK



1307 FB



1307 FZ



1307 HE



1307 MN



1307 MO



1307 MR



1307 PZ



1307 RB



1307 RK



1307 VK



1307 VZ



1308 AP



1308 AS



1308 CB



1308 MT



1308 SN

PIER MOUNTS

ITEM	FINISH	DIAMETER	BASE HEIGHT	FITTER DIAMETER	ITEM	FINISH	DIAMETER	BASE HEIGHT	FITTER DIAMETER
1301 BK	Black	3"	¼"	3"	1307 MR	Museum Bronze	7"	2"	3"
1304 BK*	Black	7"	2"	3"	1307 PZ	Pearl Bronze	7"	2"	3"
1305 BK	Black	7"	2"	3"	1307 RB	Regency Bronze	7"	2"	3"
1307 BG	Black Granite	7"	2"	3"	1307 RK	River Rock	7"	2"	3"
1307 BK	Black	7"	2"	3"	1307 VK	Vintage Black	7"	2"	3"
1307 FB	Forum Bronze	7"	2"	3"	1307 VZ	Victorian Bronze	7"	2"	3"
1307 FZ	French Bronze	7"	2"	3"	1308 AP	Antique Copper	7"	2"	3"
1307 HE	Hematite	7"	2"	3"	1308 AS	Aged Brass	7"	2"	3"
1307 MN	Midnight Bronze	7"	2"	3"	1308 CB	Copper Bronze	7"	2"	3"
1307 MO	Mocha	7"	2"	3"	1308 MT	Metro Bronze	7"	2"	3"
					1308 SN	Sienna	7"	2"	3"

Mounting hardware not included. *Concealed fasteners.

LANDSCAPE

NIGHT ILLUMINATED



“Landscape lighting encourages people to step outside and creates a wonderful indoor-outdoor connection beyond daylight hours.”

- AMY ELBERT

Hinkley provides a collection of decorative and functional landscape lighting to help you complete your home's lighting plan. Whether you choose to highlight architectural features of your home, extend your living space, or accentuate an object of interest, we have the perfect fixtures to meet your lighting needs. To view the complete collection of Hinkley Landscape Lighting, see our Full-Line Landscape Lighting Catalog or visit us online at www.hinkleylandscapelighting.com

PATH & AREA LIGHTING



Additional finishes and styles are available. See the Hinkley Landscape Lighting Full-Line Catalog, or visit us online.



 available in LED

1548 TT



 available in LED

1518 BZ



1579 SS



1560 AR



 available in LED

1561 AR



1547 KZ



1514 VZ



1516 MR

PATH & AREA LIGHTING

ITEM	NAME	WIDTH	HEIGHT	LAMP INCLUDED	COMPANION OUTDOOR FAMILY	AVAILABLE FINISHES	
1514 VZ	Reef	4½"	28"	921 18w T5 Wedge Base (included)	Pages 294-295	VZ	
1516 MR	Ledgewood	5"	22"	921 18w T5 Wedge Base (included)	Pages 320-323	MR, VK	
1518 BZ	Atlantis	6½"	22"	T3 (20w) (included)	Pages 266-273	BZ, TT, HE	•
1547 KZ	Dwell	4½"	22¼"	921 18w T5 Wedge Base (included)	Pages 288-293	HE, KZ	
1548 TT	Piza	2¾"	15"	921 18w T5 Wedge Base (included)		BZ, TT	•
1560 AR	Harbor	7"	24"	921 18w T5 Wedge Base (included)	Pages 296-299	AR	
1561 AR	Harbor	7½"	21"	921 18w T5 Wedge Base (included)	Pages 296-299	AR, TT	•
1579 SS	Saturn	4½"	22"	921 18w T5 Wedge Base (included)	Pages 260-263	MT, SS	

AVAILABLE OPTIONS

Fixture shown on page 408: Mirabella 1567 RY, page 410

For an explanation of icons, see page 4.

©2011 Hinkley Lighting Inc. www.hinkleylighting.com

PATH & AREA LIGHTING



1508 CB



1523 VZ



1555 CB



1513 MB



1529 CB



1593 OB



1540 CB



1527 CB



1567 RY



1403 OC

PATH & AREA LIGHTING

ITEM	NAME	WIDTH	HEIGHT	LAMP INCLUDED	COMPANION OUTDOOR FAMILY	AVAILABLE FINISHES
1403 OC	Small Essence Hammered	6"	16¾"	921 18w T5 Wedge Base (included)		OC
1508 CB	Ivy	8¼"	26"	921 18w T5 Wedge Base (included)		CB
1513 MB	Raley	5½"	22"	921 18w T5 Wedge Base (included)	Pages 396-397	MB
1523 VZ	Thistledown	6¾"	22"	921 18w T5 Wedge Base (included)	Pages 316-317	VZ
1527 CB	Bratenahl	8"	22"	921 18w T5 Wedge Base (included)		CB
1529 CB	Plantation	3¾"	22"	921 18w T5 Wedge Base (included)	Pages 382-387	CB
1540 CB	Monticello	8"	22"	921 18w T5 Wedge Base (included)	Pages 350-351	CB
1555 CB	Bratenahl	7¼"	25"	921 18w T5 Wedge Base (included)		CB
1567 RY	Mirabella	8"	22"	921 18w T5 Wedge Base (included)		RY
1593 OB	Bolla	8"	22"	921 18w T5 Wedge Base (included)	Pages 300-303	OB

HARDY ISLAND COLLECTION

THIS HEAVY DUTY, SOLID CAST BRASS COLLECTION IS A STRIKING COLLABORATION OF FORM AND FUNCTION.

Designed to withstand the harshest environments in style, Hardy Island offers fully enclosed lamps and a finish that ages naturally through oxidation and patina. Named for the ruggedly beautiful island off the coast of British Columbia that bears its name, Hardy Island is rated for coastal applications and offers an extended warranty due to the strength of its cast brass construction.



16704 MZ



16701 MZ



16801 MZ



16501 MZ



16504 MZ



16577 MZ



16574 MZ



16001 MZ



16007 MZ



16013 MZ



16019 MZ



16055 MZ

HARDY ISLAND

ITEM	NAME	DIAMETER	HEIGHT	LENGTH	CONSTRUCTION	GLASS/LENS	LAMP INCLUDED	AVAILABLE FINISHES
16001 MZ	Large Ribbed Brass Path Light	7"	23½"		Brass	Frosted Glass Dome	T3 (20w)	MZ
16007 MZ	Large Textured Brass Path Light	6¾"	23¼"		Brass	Frosted Glass Dome	T3 (20w)	MZ
16013 MZ	Small Classic Brass Path Light	5¼"	23¼"		Brass	Frosted Glass Dome	T3 (20w)	MZ
16019 MZ	Large Classic Brass Path Light	8"	24"		Brass	Frosted Glass Dome	T3 (20w)	MZ
16055 MZ	Large Smooth Brass Path Light	6½"	22"		Brass	Frosted Acrylic Lens	T3 (20w)	MZ
16501 MZ	MR11 Brass Spot Light	1¾"	5½"	4¾"	Brass	Clear Tempered Glass Lens	MR11 (35w)*	MZ
16504 MZ	Brass Bullet Spot Light	3¾"	6½"	8¾"	Brass	Clear Tempered Glass Lens	MR16 (20w)*	MZ
16574 MZ	Large Brass Wall Wash	6¼"	8"	5¾"	Brass	Frosted Glass Lens	T4 (50w)	MZ
16577 MZ	Large Brass Flood Light	4½"	7¼"	6"	Brass	Clear Tempered Glass Lens	Par36 (50w)*	MZ
16701 MZ	Flat Top Brass Well Light	4"	3¾"		Brass	Clear Tempered Glass Lens	MR16 (20w)*	MZ
16704 MZ	Grill Top Brass Well Light	4"	4"		Brass	Clear Tempered Glass Lens	MR16 (20w)*	MZ
16801 MZ	Brass Deck Sconce	3½"			Brass	Clear Tempered Glass Lens	T3 (20w)	MZ

*Lamp not included.

DECK, STEP & ACCENT LIGHTING

Enhance your outdoor lighting by adding fixtures to your deck, porch and steps. Use spot, flood and well lights to showcase the beautiful architectural elements of your home, using techniques such as grazing and uplighting.



1539 BS



1521 BZ



1536 BZ



1583 NC



1546 BZ



1549 BZ



1524 BZ



1594 BZ

(also available in LED)

LED LIGHTING



(lens view)



16504 MZ-LED30
16504 MZ-LED60



1537 BZ-LED30
1537 BZ-LED60



1594 BZ-LED



58009 BZ-LED



1594 MZ-LED



59009 BZ-LED

ITEM	NAME	WIDTH/DIA.	HEIGHT	DEPTH	LAMP	AVAILABLE FINISHES	
1521 BZ	50w Flood Light with Frosted Lens	5½" W	6¼"	5"	T4 up to 50w	BZ	
1524 BZ	Square Deck Sconce	3½" W	3½"	2¼"	906 (7w) Wedge Base (included)	BZ, MW	
1536 BZ, 1536 MZ	50w MR-16 Spot Light	2½" Dia.	3¼"	5¾"	Up to 50w MR-16	BZ, MZ	
1537 BZ-LED30	12v 8½w LED 30° Brass Spot Light	3¾" Dia.	6⅝"	8½"	8.5w 12v	BZ	•
1537 BZ-LED60	12v 8½w LED 60° Brass Spot Light	3¾" Dia.	6⅝"	8½"	8.5w 12v	BZ	•
1539 BS	50w MR-16 Brass Submersible Pond Light	3¾" Dia.	4½"	3¾"	Up to 50w MR-16	BS	
1546 BZ	Horizontal Deck Light	4¾" W	3¼"	½"	906 (7w) Wedge Base (included)	BZ, CO, MZ	
1549 BZ	Round Deck Sconce	3¾" Dia.	3¾"	2"	906 (7w) Wedge Base (included)	BZ, MW	
1583 NC	50w MR-16 Copper Spot Light	2" Dia.	2½"	7"	Up to 50w MR-16	NC	
1594 BZ	Louvered Brick Light	8¾" W	3¼"	½"	912 (12w) Wedge Base (included)	BZ, MZ	•
1594 BZ-LED	Louvered Brick Light	8¾" W	3¼"	½"	1.2w 12v	BZ, MZ	•
1594 MZ-LED	Louvered Brick Light	8¾" W	3¼"	½"	1.2w 12v	BZ, MZ	•
16504 MZ-LED30	12v 8½w LED 30° Spot Light	3¾" Dia.	6½"	8¾"	8.5w 12v	MZ	•
16504 MZ-LED60	12v 8½w LED 60° Spot Light	3¾" Dia.	6½"	8¾"	8.5w 12v	MZ	•
58009 BZ-LED	120v Step Light	7½" W	4¾"	5⅞"	1.2w 12v	BZ	•
59009 BZ-LED	120v Brick Light	10" W	3½"	1"	1.2w 12v	BZ	•

AVAILABLE
OPTIONS

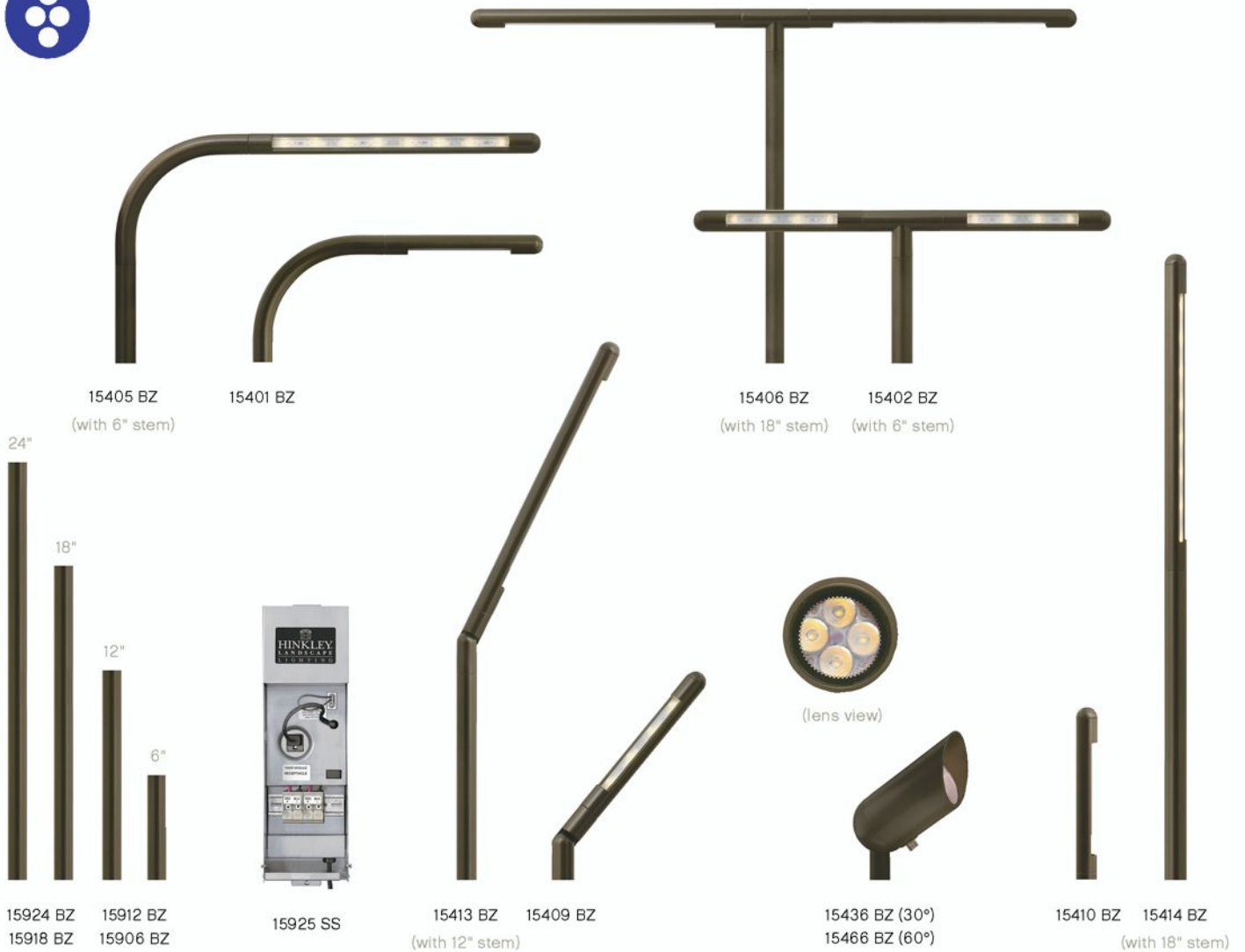

NEXUS 15v DC LED High Performance Landscape Lighting System

ITEM	WIDTH	HEIGHT	WIRE LENGTH	DESCRIPTION	GLASS/LENS	LED WATTAGE	LUMENS	INCANDESCENT EQUIVALENCY
15401 BZ	14½"	7"	36"	90° Elbow with 3w LED	High Impact Acrylic	3w 15v DC	140	12w
15402 BZ	19½"	2½"	36"	T-Connector with (2) 3w LED	High Impact Acrylic	(2) 3w 15v DC	280	20w
15405 BZ	21"	7"	36"	90° Elbow with 6w LED	High Impact Acrylic	6w 15v DC	280	20w
15406 BZ	32"	2½"	36"	T-Connector with (2) 6w LED	High Impact Acrylic	(2) 6w 15v DC	560	35w
15409 BZ	1", 9¾" Max.	2¼", 11¾" Max.	36"	180° Swivel with 3w LED	High Impact Acrylic	3w 15v DC	140	12w
15410 BZ	1"	8"	36"	Mini-Bollard with 3w LED	High Impact Acrylic	3w 15v DC	140	12w
15413 BZ	1", 15¾" Max.	2¼", 17¾" Max.	36"	180° Swivel with 6w LED	High Impact Acrylic	6w 15v DC	280	20w
15414 BZ	1"	14"	36"	Mini-Bollard with 6w LED	High Impact Acrylic	6w 15v DC	280	20w
15436 BZ	2½" Dia. (shroud)	¾", 5¾" Length	36"	30° LED Spot Light	Clear Tempered	6w 15v DC	325	30w
15466 BZ	2½" Dia. (shroud)	¾", 5¾" Length	36"	60° LED Spot Light	Clear Tempered	6w 15v DC	325	30w
15906 BZ	1"	6"		6" Nexus Stem				
15912 BZ	1"	12"		12" Nexus Stem				
15918 BZ	1"	18"		18" Nexus Stem				
15924 BZ	1"	24"		24" Nexus Stem				
15925 SS*	5½"	17"		Stainless Steel 15v Driver		150w Max.		

*Additional drivers can be found in Hinkley's Landscape Lighting Catalog. Ground spike and wiring kit included. Timers, photocells and additional accessories can be found in Hinkley's Landscape Lighting Catalog.

INDEX

1100

1120 MR	321
1120 VK	323
1121 MR	321
1121 VK	323
1122 MR	321
1122 VK	323
1124 MR	321
1124 VK	323
1125 MR	321
1125 VK	323
1126 MR	321
1126 VK	323
1129 MR	320
1129 VK	322
1140 OL	315
1141 OL	315
1142 OL	315
1144 OL	315
1145 OL	314
1150 RB	311
1151 RB	311
1152 RB	311
1154 RB	311
1155 RB	310
1180 SN	363
1181 SN	363
1182 SN	363
1184 SN	363
1185 SN	362

1200

1240 MN	345
1241 MN	345
1242 MN	345
1243 MN	345
1244 MN	345
1245 MN	344
1250 RB	305
1251 RB	305
1252 RB	305
1253 RB	305
1254 RB	305
1255 RB	304
1256 RB	305
1270 VK	337
1271 VK	337
1272 VK	337
1273 VK	337
1274 VK	337
1275 VK	336
1280 VZ	317
1281 VZ	317
1282 VZ	317
1284 VZ	317
1285 VZ	316
1286 VZ	317

1300

1301 BK	407
1304 BK	407

1305 BK	407
1307 BG	407
1307 BK	407
1307 FB	407
1307 FZ	407
1307 HE	407
1307 MN	407
1307 MO	407
1307 MR	407
1307 PZ	407
1307 RB	407
1307 RK	407
1307 VK	407
1307 VZ	407
1308 AP	407
1308 AS	407
1308 CB	407
1308 MT	407
1308 SN	407
1311 MB	333
1311 MO	332
1312 MB	333
1312 MO	332
1314 MB	333
1314 MO	332
1315 MB	333
1315 MO	332
1316 MB	333
1316 MO	332
1319 MB	333
1319 MO	332
1320 BK	289
1320 HE	293
1320 KZ	291
1321 BK	289
1321 HE	293
1321 KZ	291
1322 BK	289
1322 HE	293
1322 KZ	291
1324 BK	289
1324 HE	293
1324 KZ	291
1325 BK	288
1325 HE	292
1325 KZ	290
1326 BK	289
1326 HE	293
1326 KZ	291
1328 BK	289
1328 HE	293
1331 MB	335
1331 MO	334
1332 MB	335
1332 MO	334
1334 MB	335
1334 MO	334
1335 MB	335
1335 MO	334
1336 MB	335
1336 MO	334

1350 AU	330
1350 MB	331
1351 AU	330
1351 MB	331
1352 AU	330
1352 MB	331
1354 AU	330
1354 MB	331
1355 AU	330
1355 MB	331
1356 AU	330
1356 MB	331
1360 BK	394
1361 BK	394
1362 BK	394
1364 BK	394
1366 BK	394
1370 BK	329
1370 OB	328
1371 BK	329
1371 OB	328
1372 BK	329
1372 OB	328
1374 BK	329
1374 OB	328
1376 BK	329
1376 OB	328
1390 BK	327
1390 BZ	325
1391 BK	327
1391 BZ	325
1392 BK	327
1392 BZ	325
1394 BK	327
1394 BZ	325
1395 BK	326
1395 BZ	324
1396 BK	327
1396 BZ	325
1397 BK	327
1397 BZ	325

1400

1403 OC	410
1410 BK	398
1412 BK	399
1419 BK	399
1420 AI	389
1421 AI	389
1422 AI	389
1424 AI	389
1425 AI	388
1430 RB	347
1431 RB	347
1432 RB	347
1434 RB	347
1435 RB	347
1438 RB	346
1440 BK	398
1441 BK	399
1445 BK	398

1449 BK	399
1450 SB	287
1452 SB	287
1454 SB	287
1455 SB	286
1470 BK	398
1471 BK	399
1472 BK	399

1500

1508 CB	410
1513 MB	410
1514 VZ	409
1516 MR	409
1518 BZ	409
1518 TT	409
1521 BZ	412
1523 VZ	410
1524 BZ	412
1527 CB	410
1529 CB	410
1536 BZ	412
1536 MZ	412
1537 BZ-LED	412
1539 BS	412
1540 CB	410
15401 BZ	413
15402 BZ	413
15405 BZ	413
15406 BZ	413
15409 BZ	413
15410 BZ	413
15413 BZ	413
15414 BZ	413
15436 BZ	413
15466 BZ	413
1546 BZ	412
1547 KZ	409
1548 TT	409
1549 BZ	412
1555 CB	410
1560 AR	409
1561 AR	409
1567 RY	410
1579 SS	409
1583 NC	412
15906 BZ	413
15912 BZ	413
15918 BZ	413
15920 WH	413
15924 BZ	413
15925 SS	413
1593 OB	410
1594 BZ	412
1594 BZ-LED	412
1594 MZ-LED	412

1600

1600 MB	397
16001 MZ	411
16007 MZ	411

1601 MB	397
16013 MZ	411
16019 MZ	411
1602 MB	397
1604 MB	397
1605 MB	397
16050 MZ	411
1606 MB	397
1609 MB	396
1610 RB	307
1611 RB	307
1612 RB	307
1613 RB	307
1614 RB	307
1615 RB	306
1616 RB	307
1640 BZ	267
1640 SK	273
1640 SW	271
1640 TT	269
1641 BZ	267
1641 SK	273
1641 SW	271
1641 TT	269
1644 BZ	267
1644 SK	273
1644 SW	271
1644 TT	269
1645 BZ	267
1645 SK	273
1645 SW	271
1645 TT	269
1646 BZ	267
1646 SK	273
1646 SW	271
1646 TT	269
1647 BZ	276
1647 SK	276
1647 SW	276
1647 TT	276
1648 BZ	266
1648 SK	273
1648 SW	271
1648 TT	268
1649 BZ	266
1649 SK	272
1649 SW	270
1649 TT	268
1650 BZ	266
1650 TT	268
16501 MZ	411
16504 MZ-LED	412
1655 BZ	266
1655 TT	268
16574 MZ	411
16577 MZ	411
1660 BZ	275
1660 SK	275
1660 TT	274
1663 BZ	277

1663 SK	277
1663 TT	277
1664 BZ	275
1664 SK	275
1664 TT	274
1666 BZ	277
1666 SK	277
1666 TT	277
1667 BZ	277
1667 SK	277
1667 TT	277
1670 BK	401
16701 MZ	411
16704 MZ	411
1671 BK	401
1672 BK	401
1674 BK	401
1675 BK	400
1676 BK	401
1677 BK	401
16801 MZ	411
1683 BK	401
1690 KZ	313
1691 KZ	313
1694 KZ	313
1695 KZ	312

1700

1700 BK	403
1701 BK	403
1702 BK	403
1704 BK	403
1705 BK	402
1707 BK	403
1712 BK	403
1713 BG	405
1720 BG	405
1721 BG	405
1722 BG	405
1725 BG	405
1726 BG	404
1727 BG	405
1729 BG	405
1730 AI	381
1731 AI	381
1732 AI	381
1734 AI	381
1735 AI	380
1736 AI	381
1760 BZ	279
1760 SK	279
1760 TT	279
1763 BZ	280
1763 SK	280
1763 SW	280
1763 TT	280
1764 BZ	278
1764 SK	279
1764 TT	279
1766 BZ	281
1766 SK	281

3877 BN	45	4163 OB	105	4312 VZ	101	4543 RB	120	4656 BN	73	4720 MC	99
3878 BN	44	4165 OB	105	4313 OL	129	4544 RB	121	4656 BR	81		241
3980 PL	55	4166 OB	105	4314 OL	129	4545 RB	121	4656 OB	75	4721 MC	99
3981 PL	55	4167 OB	105	4316 OL	129	4546 RB	120	4657 BN	73		241
3982 PL	55	4168 OB	104	4371 PL	53	4547 RB	121	4657 BR	81	4722 MC	99
3983 PL	55	4170 VZ	101		214	4548 RB	120	4657 OB	75	4723 MC	99
3985 PL	55	4171 VZ	101		229	4561 AT	111	4659 BN	72	4724 MC	99
3987 PL	55		242		231	4563 AT	111	4659 BR	80	4725 MC	99
3988 PL	54		317		233	4564 AT	111	4659 OB	76	4727 MC	99
		4173 VZ	101	4373 PL	53	4566 AT	111			4728 MC	98
		4174 VZ	102	4374 PL	53	4567 AT	111	4660 BN	75	4729 MC	98
		4176 VZ	101	4375 PL	53	4568 AT	111		236	4772 SL	137
		4177 VZ	101	4377 PL	53	4569 AT	110	4660 BR	83	4775 SL	137
		4178 VZ	101	4378 PL	53	4570 KZ	97		237	4776 SL	137
		4179 VZ	100	4379 PL	52	4571 KZ	97	4660 OB	79	4778 SL	136
						4572 KZ	97		238	4780 CM	49
						4574 KZ	97	4661 BN	74	4784 CM	49
						4575 KZ	97	4661 BR	82	4785 CM	49
						4576 KZ	96	4661 OB	78	4788 CM	48
						4577 KZ	97	4662 BN	74	4790 BN	57
						4590 RY	119	4662 BR	82	4790 EZ	60
						4591 RY	119	4662 OB	78	4791 BN	58
						4594 RY	119	4663 BN	75	4791 EZ	61
						4595 RY	119	4663 BR	83	4792 BN	57
						4598 RY	119	4663 OB	79	4792 EZ	60
						4599 RY	118	4664 BN	75	4793 BN	58
								4664 BR	83	4793 EZ	61
								4664 OB	79	4794 BN	58
								4665 BN	75	4794 EZ	61
								4665 BR	83	4795 BN	57
								4665 OB	79	4795 EZ	60
								4666 BN	74	4796 BN	58
								4666 BR	82	4796 EZ	61
								4666 OB	78	4797 BN	58
								4667 BN	74	4797 EZ	61
								4667 BR	82	4798 BN	57
								4667 OB	78	4798 EZ	60
								4669 BN	75	4799 BN	56
								4669 BR	83	4799 EZ	59
								4669 OB	79		
								4680 OZ	95		
								4681 OZ	95	4800 SU	132
								4682 OZ	95	4801 SU	132
								4684 OZ	95	4802 SU	131
								4685 OZ	94	4803 SU	132
								4690 SR	51	4805 SU	132
								4693 SR	51	4806 SU	132
								4696 SR	51	4807 SU	131
								4698 SR	50	4808 SU	131
										4809 SU	131
										4880 BB	139
										4880 PL	146
										4880 PZ	143
										4881 BB	141
											249
										4881 CB	383
										4881 PL	147
											250
										4881 PZ	145
										4882 BB	140
										4882 CB	384
										4882 PZ	144
										4883 BB	139
										4883 PL	146
										4883 PZ	143
										4885 BB	141
										4885 PL	147
										4885 PZ	145

4886 BB	139	5072 CM	208	5253 AN	205	5434 PL	234	5680 VZ	101	5873 PL	231
4886 PL	146	5073 BN	209	5253 CM	204	5450 AT	111		242	5874 PL	231
4886 PZ	143	5073 CM	208	5254 AN	205	5470 OB	115	5682 VZ	242	5892 BN	236
4887 BB	139	5074 BN	209	5254 CM	204		239	5683 VZ	242	5892 BR	237
4887 PZ	143	5074 CM	208	5255 AN	205	5472 OB	239	5684 VZ	242	5892 OB	238
4889 BB	138	5080 CM	195	5255 CM	204	5473 OB	239			5893 BN	236
4889 PZ	142	5082 CM	195			5474 OB	239	5700		5893 BR	237
4891 SU	131	5083 CM	195	5300				5700 CM	47	5893 OB	238
4892 SU	131	5084 CM	195	5310 BB	140	5500			203	5894 BN	236
4893 SU	133				249	5500 BN	198	5702 CM	203	5894 BR	237
4896 SU	132	5100		5310 PL	147	5502 BN	198	5703 CM	203	5894 OB	238
4897 SU	133	5100 AN	220		250	5503 BN	198	5704 CM	203	5895 BN	236
4899 SU	130	5100 BR	221	5310 PZ	144	5504 BN	198	5732 MC	241	5895 BR	237
		5102 AN	220	5312 BB	249	5505 BN	198	5733 MC	241	5895 OB	238
4900		5102 BR	221	5312 PL	250	5520 CM	194	5734 MC	241		
4900 BN	57	5103 AN	220	5313 BB	249	5522 CM	194	5750 AN	230	5900	
4900 EZ	60	5103 BR	221	5313 PL	250	5523 CM	194	5750 BR	230	5920 BN	223
4970 BN	43	5104 AN	220	5314 BB	249	5524 CM	194	5752 AN	230	5922 BR	224
4971 BN	43	5104 BR	221	5314 PL	250	5542 OL	243	5752 BR	230	5920 CM	222
4972 BN	43	5105 AN	220	5317 BB	141	5543 OL	243	5753 AN	230	5922 BN	223
4975 BN	43	5105 BR	221	5317 PL	146	5544 OL	243	5753 BR	230	5922 BR	224
4976 BN	43	5120 PB	163	5317 PZ	145	5545 OL	243	5770 BN	200	5922 CM	222
4978 BN	42	5120 PW	161	5370 BN	232	5550 BN	207	5772 BN	200	5923 BN	223
		5122 BK	152	5372 BN	232	5550 CM	206	5773 BN	200	5923 BR	224
5000			161	5373 BN	232	5551 BN	197	5774 BN	200	5923 CM	222
5000 AN	229		163	5375 BN	232		198	5780 CM	235	5924 BN	223
5002 AN	229	5124 PB	163	5390 BB	246		207	5781 CM	235	5924 BR	224
5003 AN	229	5124 PW	161	5390 PL	245		232	5782 CM	235	5924 CM	222
5004 AN	229	5126 PB	163	5391 BB	246	5551 BR	215	5783 CM	235	5924 CM	222
5010 BN	211	5126 PW	161	5391 PL	245	5551 CM	196	5784 CM	235	5925 BN	223
5010 CM	210	5127 PB	162	5392 BB	246		206			5925 BR	224
5012 BN	211	5127 PW	160	5392 PL	245	5551 OZ	15	5800		5925 CM	222
5012 CM	210	5128 PB	163	5393 BB	246	5552 BN	207	58009 BZ-LED	412	5980 CM	212
5013 BN	211	5128 PW	161	5393 PL	245	5552 CM	206			5982 CM	212
5013 CM	210	5129 PB	163	5394 BB	246	5553 BN	207	5820 BH	244	5983 CM	212
5014 BN	211	5129 PW	161	5394 PL	245	5553 CM	206	5822 BH	244	5984 CM	212
5014 CM	210	5130 CM	193			5554 BN	207	5823 BH	244		
5020 BN	197	5132 CM	193	5400		5554 CM	206	5824 BH	244	6200	
5020 CM	196	5133 CM	193	5420 CM	202	5556 BN	207	5830 AN	214	6212 BN	41
5022 BN	197	5134 CM	193	5421 BN	209	5556 CM	206	5830 BR	215		69
5022 CM	196	5135 CM	193		211	5560 VZ	113	5832 AN	214	6212 OZ	95
5023 BN	197	5170 BN	192		217		240	5832 BR	215		
5023 CM	196	5172 BN	192		219	5562 VZ	240	5833 AN	214	6600	
5024 BN	197	5173 BN	192		220	5563 VZ	240	5833 BR	215	6610 BK	406
5024 CM	196	5174 BN	192		226	5564 VZ	240	5834 AN	214	6611 BK	406
5025 BN	197	5190 CM	199		230	5580 BB	247	5834 BR	215	6637 BK	406
5025 CM	196	5191 CM	199	5421 BR	218	5580 PL	248	5850 BC	218	6638 BK	406
5050 BC	227	5192 CM	199		219	5582 BB	247	5850 BN	217	6660 BK	406
5050 BN	226	5193 CM	199		221	5582 PL	248	5850 CM	216	6660 BZ	406
5050 CM	225	5194 CM	199		227	5583 BB	247	5852 BC	218	6660 OI	406
5052 BC	227				227	5583 PL	248	5852 BC	218	6661 BK	406
5052 BN	226	5200		5421 CM	194	5583 PL	248	5852 BN	217	6662 BK	406
5052 CM	225	5210 BN	201		195	5584 BB	247	5852 CM	216	6663 BK	406
5053 BC	227	5212 BN	201		202	5584 PL	248	5853 BC	218	6667 BK	406
5053 BN	226	5213 BN	201		203	5585 BB	247	5853 BN	217	6680 BK	406
5053 CM	225	5214 BN	201		208	5585 PL	248	5853 CM	216		
5054 BC	227	5220 BN	228		210	5590 BN	45	5854 BC	218	6800	
5054 BN	226	5222 BN	228		212		191	5854 BN	217	6808 BK	406
5054 CM	225	5223 BN	228		216	5590 CM	190	5854 CM	216	6810 BK	406
5062 BN	219	5224 BN	228		225	5592 BN	191	5855 BC	218	6812 BK	406
5062 BR	219	5250 AN	205	5421 OZ	16	5592 CM	190	5855 BN	217		
5064 BN	219	5250 CM	204	5422 CM	202	5593 BN	191	5855 CM	216		
5064 BR	219	5251 AN	205	5423 CM	202	5593 CM	190	5860 PL	233		
5066 BN	219	5251 BR	16	5424 CM	202	5594 BN	191	5862 PL	233		
5066 BR	219	5251 CM	204	5430 PL	234	5594 CM	190	5863 PL	233		
5070 BN	209	5251 OZ	16	5431 PL	234			5864 PL	233		
5070 CM	208	5252 AN	205	5432 PL	234	5600		5870 PL	53		
5072 BN	209	5252 CM	204	5433 PL	234	5640 OL	125		231		
						5670 OB	105	5872 PL	231		



Daisy Breakfast

- Homemade Granola with yogurt or milk \$3.99
- Jimmy Stack Ents \$3.49
- Biscuit with jam \$1.69
- add bacon, ham, or sausage \$1.99
- Meat, Egg & Cheese Biscuit \$4.99
- choice of bacon, ham or sausage
- French Toast \$5.99
- Egg & Cheese Breakfast \$5.99
- choice of toast or biscuit, and grits
- add bacon, ham or sausage \$1.99
- Cheese Omelet \$4.99
- add meat, tomatoes, onions, or peppers \$1.50
- Bagel with lox \$7.99
- Bowl of Oatmeal \$2.99

Daisy Sandwiches

- Create your own sandwich for register \$5.99
- Pimento Cheese Sandwich \$5.99
- add Bacon and grill \$1.99
- Pulled Pork Sandwich \$7.50
- barbecue pork or ham with coleslaw
- Roll Wrap \$7.99
- turkey, Swiss cheese, tomato, avocado, potato chips & mayo
- Veggie Grill \$6.99
- veggie, arugula, fresh mushrooms \$5.99
- add potato, homemade burger \$7.99
- add potato, island \$8.50
- Daisy Entree choice of cheese, lettuce, tomato, onion

Daisy Salads

- Blue Bird Salad \$12.99
- tomato, avocado, cucumber, tomatillo, jalapeno \$7.99
- Salad Trio \$7.99
- Sweet potato, kale, tricolor salad, vinaigrette
- Daisy Citrus Salad \$7.99
- turkey, ham, Swiss cheese, tomato, hard-boiled egg on rice with potato salad
- California Salad \$6.99
- goat cheese, feta, mixed greens, labneh, vinaigrette
- Arugula & Pear Salad \$6.99/\$3.99
- roasted meats, blue cheese, apple vinaigrette
- Antipasta Salad \$7.99/\$4.99
- salami, provolone, parmesan, chickpeas, olives, celery, tomato, cucumber, romaine, vinaigrette
- Asian Slaw Salad \$7.99
- cabbage, carrot, peppers, pork, & peanut dressing
- Celery Snack \$3.49
- Deviled Eggs \$2.99
- For Kids \$2.99
- PB & J, grilled cheese, turkey & cheese

Daisy Drinks

- Americano \$2.50
- Mocha \$3.50
- Latte \$3.25
- Espresso \$1.95
- Cappuccino \$3.75
- Coffee \$1.75
- Chai Latte \$2.75
- Hot Tea \$1.75
- Hot Coffee \$1.75
- Apple \$2.00
- Specialty Sodas \$1.00
- Soft Drinks \$2.75
- Fresh Orange Juice \$2.75
- Apple & Cranberry Juice \$1.00

THIS CATALOG INCLUDES A LARGE OFFERING OF PRODUCTS THAT MEET SPECIFIC ENVIRONMENTAL GUIDELINES.

Consistent with our corporate strategy, we have printed this catalog using vegetable-based inks, paper made with wind power and FSC certified paper which consists of 10% post-consumer recovered fiber. Our paper selection preserves 222 trees for the future and prevents 20,522 lbs of greenhouse gases from being emitted into the atmosphere.

Please consider joining our environmental efforts and consider recycling this catalog by passing it along to your family and friends.



Hinkley Lighting stands behind the quality of our lighting fixtures with product warranties that are among the strongest in the industry. For details of warranty coverage on specific products, please refer to www.hinkleylighting.com or consult a qualified Hinkley retail distributor.



Hinkley Lighting is a proud partner of the American Lighting Association

© 2011 Hinkley Lighting, Inc. All rights reserved in all copyrightable works.
The majority of newer Hinkley Lighting fixtures are U.S. Patent Pending.



HINKLEY.
L I G H T I N G
design • illuminate • enjoy

12600 Berea Road | Cleveland, Ohio 44111
Phone 216.671.3300 | Fax 216.671.4537
Showrooms 3210 + 3220
Dallas Trade Mart | Dallas, Texas 75207

hinkleylighting.com
fredrickramond.com
hinkleylandscapelighting.com



HINKLEY
L A N D S C A P E
L I G H T I N G



FREDRICK RAMOND
ESTABLISHED 1988



The Hinkley Lighting family is committed to keeping your "Life Aglow" and we are united in our efforts to support breast cancer research and funding initiatives. Through our participation at both national and local levels, we are proud to contribute financially to fund research, generate awareness and encourage education. Our mission is to help eliminate breast cancer as a health concern through our passionate involvement and commitment to this important cause that affects so many of our employees, our families and our customers.



2011-2012 CATALOG

CAT11

